

RENEWABLE ENERGY PRODUCT & PARTS CATALOG

CONTENTS

About Sensata Technologies	1
Renewable Energy and Magnum Energy Brand Products	2
Magnum Energy Brand Inverter / Charger Features.....	3

GRID-TIE INVERTERS

MicroGT 500 Inverter	4
----------------------------	---

CONNECT BATTERY-BACKUP TO GRID-TIE

MS-PAE 120/240V Series Inverter / Charger	6
ACLD-40	8

CHARGE CONTROLLERS FOR BETTER BATTERY BACKUP

PT-100 Charge Controller.....	10
-------------------------------	----

INTERCONNECTION SYSTEM EQUIPMENT

MMP – Mini Magnum Panel	12
MPSL – Magnum Panel	13
MPSL250-30D/MPSL175-30D Configurations	14
MPSL250-60S Configurations	15
MPSH – Magnum Panel	16
MPSH250-30D/MPSL175-30D Configurations	17
MPDH – Magnum Panel	18
MPDH250-30D/MPDH175-30D Configurations	19
Magnum Panel Selection Guide	20
Backplate for MMP	22
Backplate Single	22
Backplate Dual	22
Breaker - AC	22
Breaker - DC, backmount	23
Breaker - DC, high capacity.....	23

DC Breakers for the PT100	40
MPX Series	23
Router Front Cover (MP-RFC)	23

INVERTER / CHARGERS

MM-AE Series Inverter / Charger	24
MMS Series Inverter / Charger	26
MS Series Inverter / Charger	28
MSH-RE Series Hybrid Inverter / Charger	30
MSH-RE Series Hybrid Technology Diagrams	32
RD Series Inverter / Charger	34

ACCESSORIES

Automatic Generator Start Module (ME-AGS).....	36
Battery Monitor Kit (ME-BMK).....	38
Conduit Box.....	40
Magnum Panel Extension Conduit Box	40
DC Breakers for the PT100	40
DC Load Disconnect.....	41
Fuse Blocks.....	41
MagWeb – Web Monitoring Kit.....	42
MagWeb GT.....	44
Outdoor Enclosure – NEMA 3R-Rated	46
Remote – ME-ARC	46
Remote – ME-RC	46
Remote – MM-RC	46
Router ME-RTR.....	46
Remote Bezel - ME-RC-BZ	47
Remote Switch Adapter.....	47
Series Stacking Cable Kit	47
Accessory & Inverter Cross Reference	48



ABOUT SENSATA TECHNOLOGIES



The name Sensata comes from the Latin word *sensata*, meaning “those gifted with sense”. To complement our business and name, our logo is inspired by Braille, the writing system based on touch.

Our highly engineered devices satisfy the world’s growing need for safety, energy efficiency, and a clean environment. These are devices that improve safety, efficiency and comfort for millions of people every day and are used in automotive, appliance, aircraft, industrial, military, heavy vehicle, heating, air conditioning, data, telecommunications, recreational vehicle and marine applications.

Until 2006, we were called Texas Instruments Sensors & Controls. Today we are the world’s leading supplier of sensors and controls across a broad range of markets and applications.

From integrated manufacturing to state-of-the-art environmental practices and a full spectrum of technical and analytical services, Sensata Technologies remains committed to helping its customers find leading-edge technology solutions to meet today’s market needs.

SENSATA POWER CONVERSION

Sensata’s Power Conversion business unit began as two well-known inverter companies, Dimensions Inverters and Magnum Energy. Dimensions Inverters joined Sensata Technologies in 2007 and Magnum Energy in 2014. Under the Magnum Energy and Dimensions Power brands, Sensata Technologies continues to manufacture exceptional inverters, inverter/chargers, and accessories catering to mobile applications, including utilities, corporate fleets, RV, marine, and trucks; renewable energy applications, and the export market.

Manufactured in Everett, Washington, and St. Paul, Minnesota, and shipped worldwide, our products use the highest quality components to respond to the extreme conditions of variable climates. Our dedicated staff of engineering, manufacturing, and customer service professionals work closely with customers to design and build some of the industry’s most reliable, advanced, and cost effective inverters, inverter/chargers and accessories.

Offering both sine wave and modified sine wave models ranging from 500 to 17,600 watts and the ability to accommodate input ranges from 12 to 48 VDC, the Magnum Energy product line has the inverter or inverter/charger to meet your needs.

For additional products, visit our web site at www.sensatapower.com. And ask your distributor/dealer for our Mobile and Export catalogs.

RENEWABLE ENERGY & MAGNUM ENERGY BRAND PRODUCTS

For reliable power regardless of grid connectivity, Magnum Energy brand inverter/chargers, interconnection system equipment, and accessories are a solid base to build a back-up or off-grid power system. With models available in 12, 24, and 48-volt configurations and power output from 600 W to 4400 W, and systems up to 17.6 kW you'll be sure to find the components right for your situation.

OFF-GRID POWER DIAGRAM

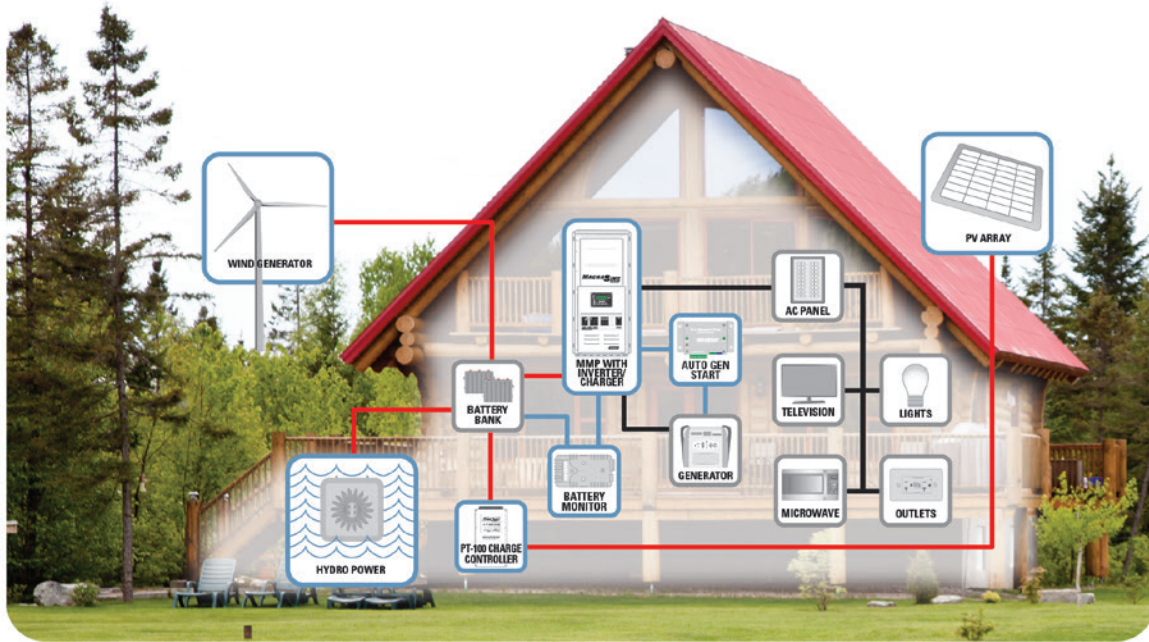

BACK-UP POWER DIAGRAM

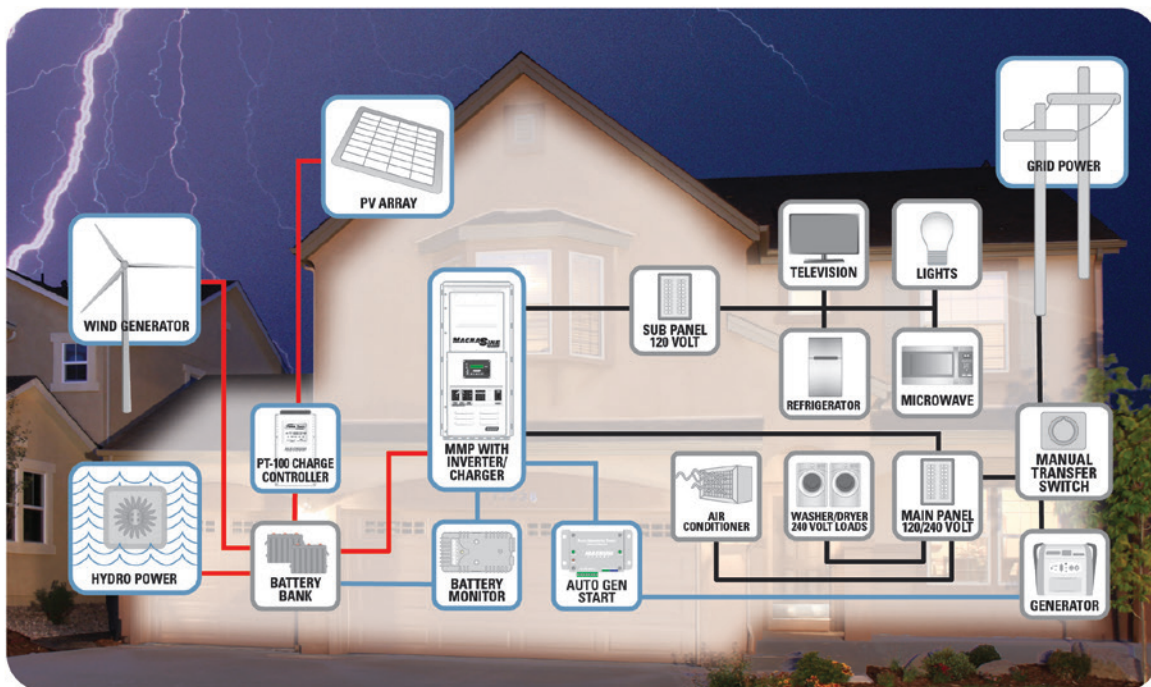

MAGNUM ENERGY BRAND INVERTER AND INVERTER/CHARGER FEATURES

SAFE AND RELIABLE

Our inverter/chargers are listed to the stringent requirements of UL and CSA.

MODIFIED SINE WAVE OR PURE SINE WAVE

Most Magnum Energy brand series inverters provide pure sine wave power. Run your TVs, stereos, tool battery chargers, computers, and other sensitive electronics without worry. Our pure sine wave inverter chargers provide clean, reliable power with low total harmonic distortion (THD) of less than 5%.

For an even more cost effective choice, Magnum Energy brand also provides modified sine wave inverters. These units will provide power that will efficiently run 90% of the electronics on the market.

POWER FACTOR CORRECTED (PFC) CHARGER

Our PFC charger is built into all of our inverter/chargers. It uses less energy from a generator than a standard charger – using 25-30% less AC current than standard chargers.

CHOICES

Magnum Energy brand inverters come in multiple power models and 12, 24, and 48 volt configurations, allowing you to choose the model that is right for you. And we provide inverters in multiple chassis configurations to fit in various space allotments.

LIGHTWEIGHT

Most Magnum Energy brand inverter/chargers are 20% lighter than comparable models. The lightweight aluminum base and cover provides noise reduction and corrosion resistance. These lighter weight models are also designed to be overnight shippable if necessary.

ACCESSIBLE DESIGN

Extra large AC access cover with terminal screw block and 360° DC connection terminals with covers make inverters more accessible when needed.

DUAL INPUTS

Some of our models allow 60 amp service from a single source to take advantage of the balanced power of a 120/240 volt generator. Other models accept two separate 120 VAC sources.

BUY WITH EASE

All inverter/chargers are backed by a three-year (36-month) or two-year (24-month) limited warranty. Purchase and install Magnum Energy inverters with a Magnum Panel enclosure and the warranty extends to five years on all parts.

ACCESSORIES TO CUSTOMIZE SYSTEMS

Available accessories include remote controls, AGS modules, a battery monitor kit, DC fuses, series stacking cable kits, and the Smart Battery Combiner (SBC). And our accessories line utilizes a more consistent design from one product to another. Our easy-to-use remote for your boat, truck, or RV is compatible with all Magnum Energy brand inverter/charger models.

FIELD REPAIRABLE

You probably won't have any problems with a Magnum Energy brand product. Our units can be field repaired, saving you time and money if your unit ever needs service.

MICROGT 500 INVERTER

Grid-Tie Microinverter Ideal for use with Battery Backup Systems
AVAILABLE SOON

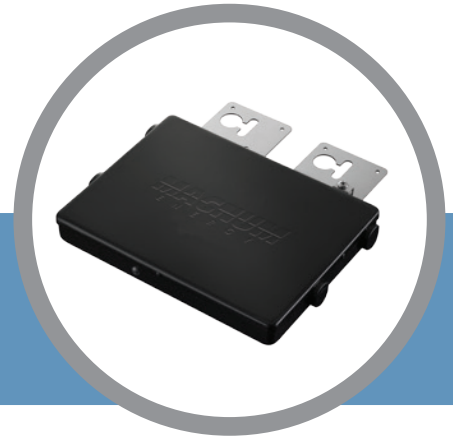

Sensata Technologies is excited to introduce the Magnum Energy brand **MicroGT 500 Inverter**. Optimized to communicate with a Magnum battery-based system, allowing the addition of battery storage, the MicroGT 500 offers a lot in a little box.

FEATURES

- Supports two modules per inverter, reducing installation labor time.
- Handles up to 310W modules with negligible clipping, delivering 250W AC per module.
- Individual MPPT for each module.
- Module-level electronics mitigates shading issues and increases system output and reliability.
- Using seven MicroGT 500 inverters, string up to 14 solar modules with a 20A breaker.
- Ready for install in your area: UL1741 and NEC690.12 compliant.
- Storage-ready: Optimized to regulate AC coupled Magnum battery-based inverters, increasing battery life.

AVAILABLE ACCESSORIES

- **MagWeb GT:** Integrated dash board shows real-time output of the MicroGT output and MS-PAE Inverter/Charger output, ME-BMK, and Magnum remote output of the battery state-of-charge
- AC termination cable
- AC extension connection cable
- Interconnection cable between inverter and MagWeb GT

MICROGT 500 INVERTER SPECIFICATIONS

INPUT	
Recommended PV Module Power Range	Power 180-310W
MPPT Voltage Range	22-45V
Maximum Input Voltage	55V
Maximum Input Current	12A X 2
OUTPUT DATA	
Rated Output Power	500W
Maximum Output Current	2.08A @ 240V
Nominal Output Voltage/Range - 240V	240V/211V-264V
Nominal Output Frequency/Range	60Hz/ 59.3-60.5Hz (Programmable per customer and utility requirements.)
Power Factor	>0.99
Total Harmonic Distortion	<3%
Maximum Units Per Branch	7 per 20A @ 240V
GENERAL SPECIFICATIONS	
Peak Efficiency	95.5%
Listings & Compliance	Emissions & Immunity (EMC) Compliance FCC PART 15, ANSI C63.4 2003, ICES-003 Safety Class Compliance Grid Connection Compliance IEEE 1547 UL 1741 , CSA C22.2, No. 107.1-01, NEC2014 690.12
Warranty	10 years standard, extendable to 25 years
ENVIRONMENTAL SPECIFICATIONS	
Operating temperature / Storage temperature	-40°F to +149°F (-40°C to +65°C) / -40°F to +185°F (-40°C to +85°C)
Enclosure rating	NEMA 6
PHYSICAL SPECIFICATIONS	
Unit dimensions (w x h x d)	8.75" x 6.5" x 1.1" (221mm x 167mm x 29mm)
Weight	5.5 lbs (2.5kg)

Testing for specifications at 25° C. Specifications subject to change without notice.

GRID-TIE WITH BATTERY BACKUP USING THE MICROGT 500 INVERTER

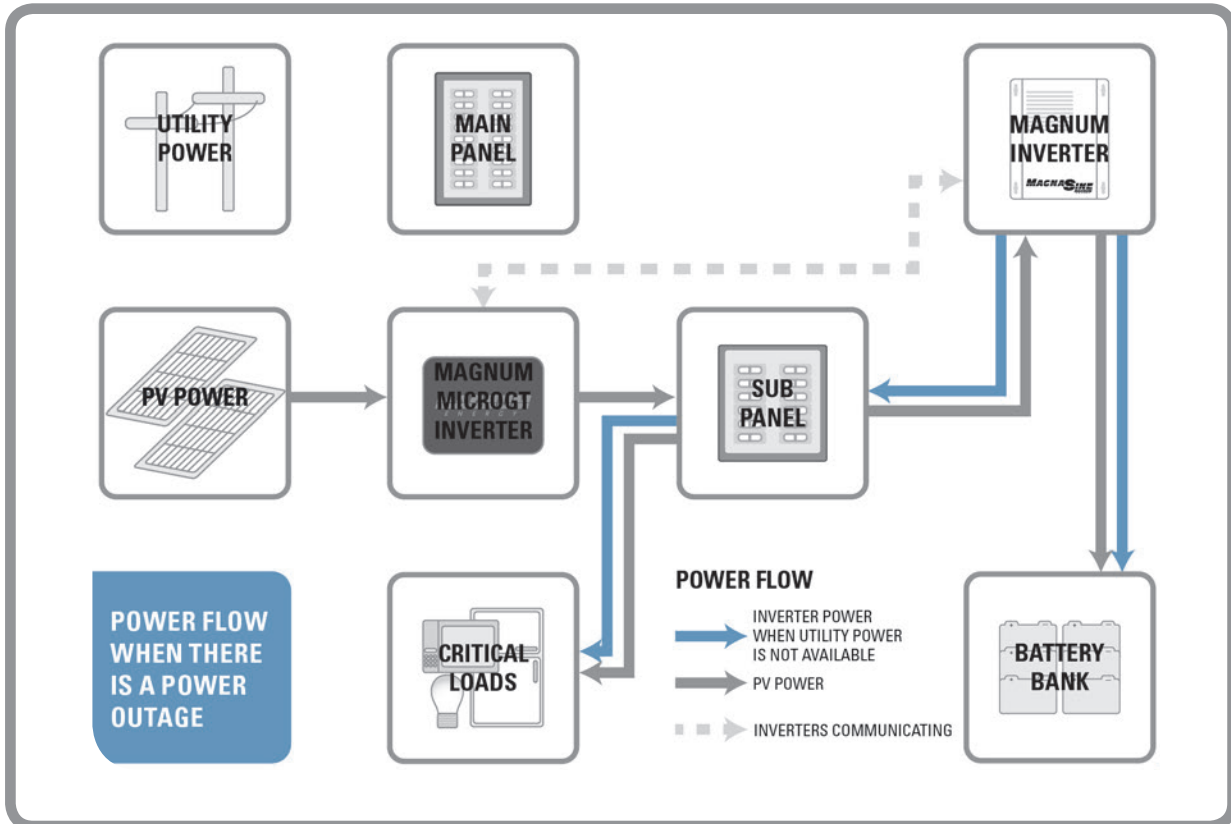
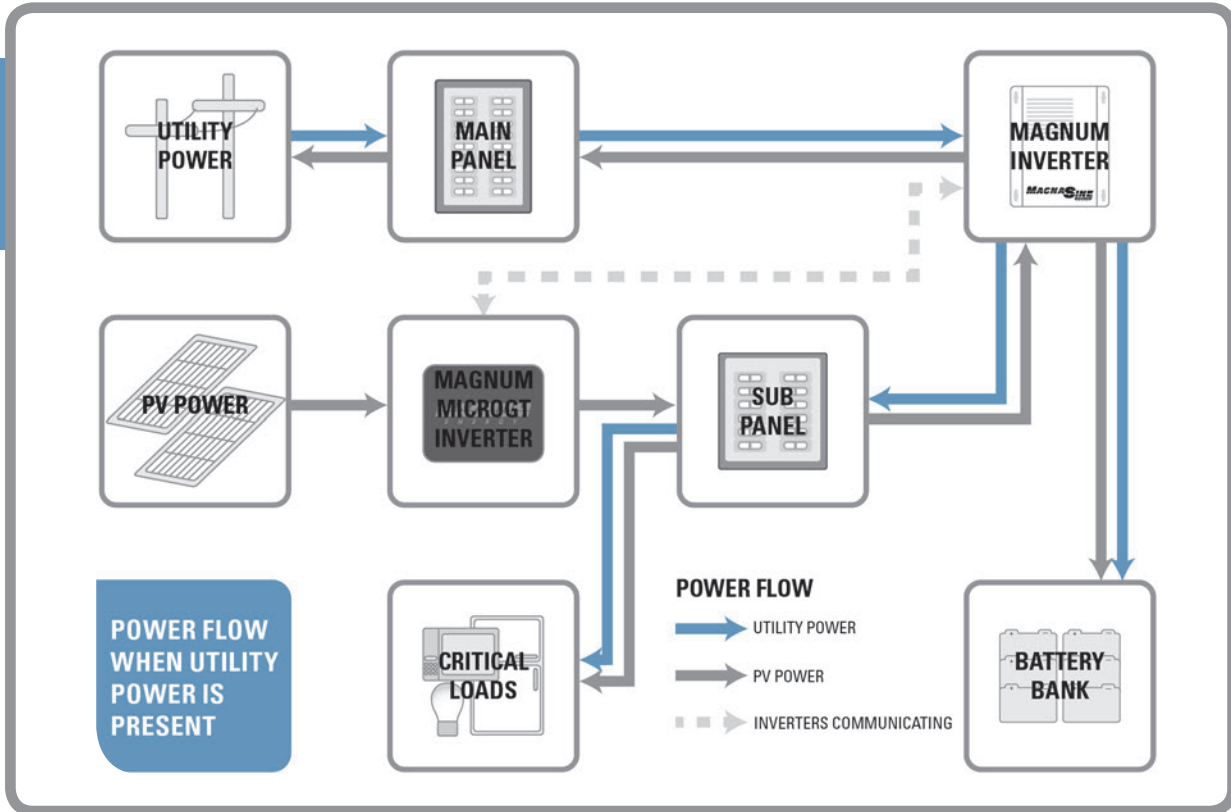

MS-PAE 120/240V SERIES INVERTER / CHARGER



Model Numbers
MS4024PAE • MS4448PAE



Pure Sine Wave



Battery Voltage Options



Continuous Output Options
in Watts

Available For

- Renewable Energy Systems
- Off-Grid Power
- Backup Power

Available Accessories

	PAGE
ACLD.....	8
AGS (ME-AGS-N)	36
Battery Monitor Kit	38
Conduit Box.....	40
Fuse Blocks.....	41
MagWeb.....	42
MP Panels	13
MMP Panels	12
PT-100 Charge Controller.....	10
Remote - ME-ARC.....	46
Remote - ME-RC.....	46
Router - ME-RTR	47

The MS-PAE and new MicroGT inverter are designed to work together to provide a seamless grid-tie with battery backup system.

Extended Warranty

- Three-year warranty standard.
- Five-year warranty if purchased with and installed on an MP or MMP panel.

The MS-PAE 120/240V Series Inverter / Charger from Sensata Technologies is a pure sine wave inverter designed specifically for the most demanding renewable energy applications. The MS-PAE Series is powerful, easy-to-use, and best of all, cost effective.

No series stacking required: The unique design of the MS-PAE Series can provide 120 and 240 volts output in one unit, eliminating the need to stack two units together to get 240 volts.

Parallel stacking: You can parallel up to four inverter / chargers for up to 17.6kw of power at 120/240V. The MP panels and router (ME-RTR) are required for parallel stacking the MS-PAE Series.

Power Factor Corrected (PFC) Charger: Our PFC charger is built into all of our inverter chargers. It uses less energy from a generator than a standard charger – using 25-30% less AC current than standard chargers.

Safe and reliable: The MS-PAE Series is ETL Listed to the stringent requirements of UL 1741, 2nd edition, and CSA C22.2 #107.1-01 for renewable energy installations.

FEATURES

Pure sine wave:

Power your T.V.s, stereos, plasma screens, and other sensitive electronics without worry. The pure sine wave inverter and power factor corrected charger provide clean, reliable inverter power with low total harmonic distortion (THD) of less than 5%.

Choices:

The MS-PAE Series comes in 24 and 48 volt configurations, allowing you to choose the model that is right for you.

Versatile mounting:

Mount the MS-PAE Series on a shelf or wall.

Lightweight:

The lightweight aluminum base and cover also provides noise reduction and corrosion resistance.

Multiple ports:

The MS-PAE Series provides multiple ports, including an RS485 communication port for network expansion, and a remote port.

Accessible design:

The extra large AC access cover with terminal screw block and 360° DC connection terminals with covers make this inverter more accessible when it needs to be.

Convenient switches:

The MS-PAE Series comes with an on/off inverter-mounted switch with an easy-to-read LED indicator.

Buy with ease:

The MS-PAE Series is backed by a three-year (36-month) limited warranty, and a five-year limited warranty when purchased with and installed on an MMP or MP system.

MS-PAE 120/240V SERIES SPECIFICATIONS

	MS4024PAE	MS4448PAE
INVERTER SPECIFICATIONS		
Input battery voltage range	18 - 34 VDC	36 - 64 VDC
Nominal AC output voltage	120/240 VAC split phase ($\pm 5\%$)	120/240 VAC split phase ($\pm 5\%$)
Output frequency and accuracy	60 Hz ± 0.1 Hz	60 Hz ± 0.1 Hz
Total Harmonic Distortion (THD)	< 5%	< 5%
1 msec surge current (amps AC)	Line-Neutral: 120, Line-Line: 70	Line-Neutral: 120, Line-Line: 70
100 msec surge current (amps AC)	Line-Neutral: 72, Line-Line: 40	Line-Neutral: 75, Line-Line: 40
5 sec surge power (real watts)	5800	8500
30 sec surge power (real watts)	5200	6000
5 min surge power (real watts)	4800	5400
30 min surge power (real watts)	4500	4800
Continuous power output at 25° C	4000 VA (L-L)	4400 VA (L-L)
Maximum continuous input current	267 A	147 ADC
Inverter efficiency (peak)	93%	94%
Transfer time	16 msec	16 msec
Search mode (typical)	< 6 watts	< 6 watts
No load (120 VAC output, typical)	27 watts	25 watts
Waveform	Pure Sine Wave	Pure Sine Wave
CHARGER SPECIFICATIONS		
Continuous output at 25° C	105 ADC	60 ADC
Charger efficiency	85%	85%
Power factor	> .95	> .95
Input current at rated output (AC amps)	15 AAC per leg at 120/240 VAC split phase	17.5 AAC per leg at 120/240 VAC split phase
GENERAL FEATURES AND CAPABILITIES		
Transfer relay capability	2 legs at 30A per leg transfer standard on all models	
Five stage charging capability	Bulk, Absorb, Float, Equalize (requires remote), and Battery Saver™	
Battery temperature compensation	Yes, 15 ft Battery Temp Sensor standard	
Internal cooling	0 to 120 cfm variable speed drive using dual 92mm brushless DC fans	
Overcurrent protection	Yes, with two overlapping circuits	
Overtemperature protection	Yes on transformer, MOSFETS, and battery	
Corrosion protection	Yes, PCB's conformal coated, powder coated chassis/top, and stainless steel fasteners	
Listings	ETL Listed to ANSI / UL1741, 2nd edition, and CSA STD C22.2 No.107.1-01	
Warranty	Three years parts and labor (five years when installed on MMP or MP system)	
ENVIRONMENTAL SPECIFICATIONS		
Temperature (Operating/Non-operating)	-20° C to +60° C (-4° F to 140° F) to -40° C to +70° C (-40° F to 158° F)	
Operating humidity	0 to 95% RH non-condensing	
PHYSICAL SPECIFICATIONS		
Dimensions (l x w x h)	13.75" x 12.65" x 8.0" (34.9 cm x 32.1 cm x 20.3 cm)	
Mounting	Shelf, wall (no vents on bottom), MP or MMP panels	
Weight	55 lb (24.9 kg)	55 lb (24.9 kg)
Shipping weight	62 lb (28.2 kg)	63 lb (29.6 kg)
Max operating altitude	15,000' (4570 m)	

Testing for specifications at 25° C. Specifications subject to change without notice.

ACLD-40

Model Number
ACLD-40



What is an ACLD – AC Load Diversion Controller?

The ACLD monitors the battery voltage of a backup battery bank, and if the voltage rises to a predetermined level, the ACLD connects a diversion load of sufficient size, to the battery or energy source to prevent the battery voltage from increasing any further. The controller will continue to engage and disengage the load as often as necessary to prevent battery overcharge.

An AC Load Diversion controller is used to divert excess energy to an AC load in an effort to keep the battery bank that is connected to a back-up inverter from being overcharged, when used in an AC Coupled application.

Available For

- Renewable Energy Systems Backup Power

Works With

	PAGE
MS-PAE Series	6
MMP Panel System	12
MP Panel System.....	13

Warranty

- Three-year warranty standard. Five-year warranty if purchased with and installed on an MP or MMP panel.

ACLD-40 Features

- Controls up to 4000 watts of excess power to prevent battery over-charge.
- Works with 24 or 48 volt systems.
- Allows the use of common, resistive AC household loads instead of hard-to-find DC loads to divert excessive current.
- Easy access Inverter and Network ports.
- Standard RS485 MagNet protocol to communicate with Magnum inverters and remotes.
- Can utilize power generated from wind, solar, or hydro systems.
- Provides PWM (Pulse Width Modulation) voltage when powering diversion load to run oad without flicker.

Note: The ACLD-40 must be connected to a MS-PAE Series inverter *and* an external diversion load.

ACLD-40 SPECIFICATIONS

ACLD-40	
ELECTRICAL SPECIFICATIONS	
Frequency	50/60 Hz
Input voltage	240 VAC ± 10%
Output voltage	0 - 240 VDC
Continuous power	4000 VA
GENERAL FEATURES AND CAPABILITIES	
Listings	ETL Listed to UL 1741 - second edition and CSA C22.2 #107.1-01
Warranty	Three years (Five years when purchased with and installed on an MP/MMP system)
ENVIRONMENTAL SPECIFICATIONS	
Operating temperature	-20° C to +60° C (-4° F to 140° F)
Nonoperating temperature	-40° C to +70° C (-40° F to 158° F)
Operating humidity	0 to 95% RH non condensing
PHYSICAL SPECIFICATIONS	
Unit dimensions (w x h x d)	11.5" x 13.75" x 7" (29.2 cm x 34.9 cm x 17.8 cm)
Shipping dimensions (w x h x d)	17" x 17" x 10" (43.2 cm x 43.2 cm x 25.4 cm)
Mounting	Shelf (top or bottom up) or Wall (vents up)
Weight	20 lb (9.1 kg)
Shipping weight	25 lb (11.3 kg)
Max operating altitude	15,000' (4570 m)

Testing for specifications at 25° C. Specifications subject to change without notice.

ACLD SYSTEM DIAGRAM WHEN UTILITY POWER IS AVAILABLE

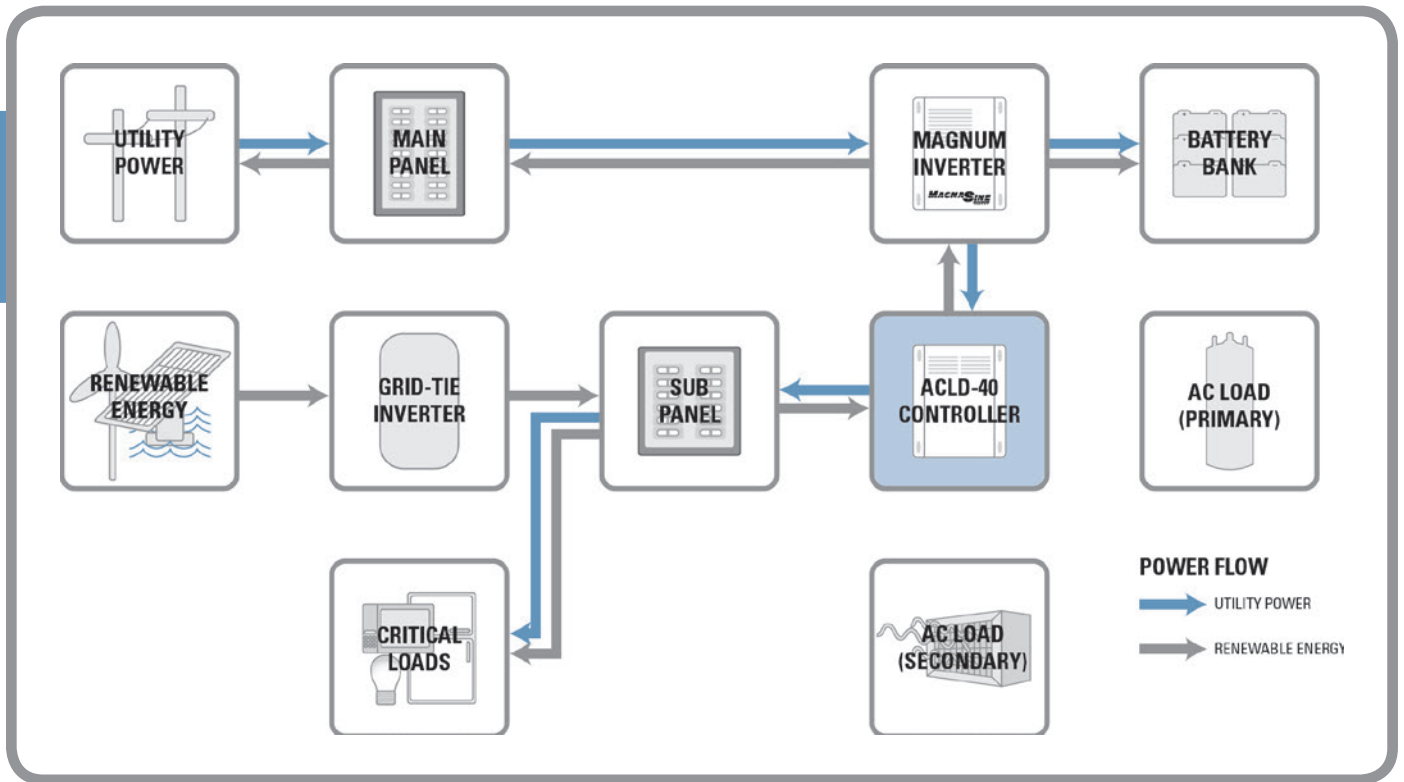

ACLD SYSTEM DIAGRAM WHEN UTILITY POWER IS **NOT** AVAILABLE

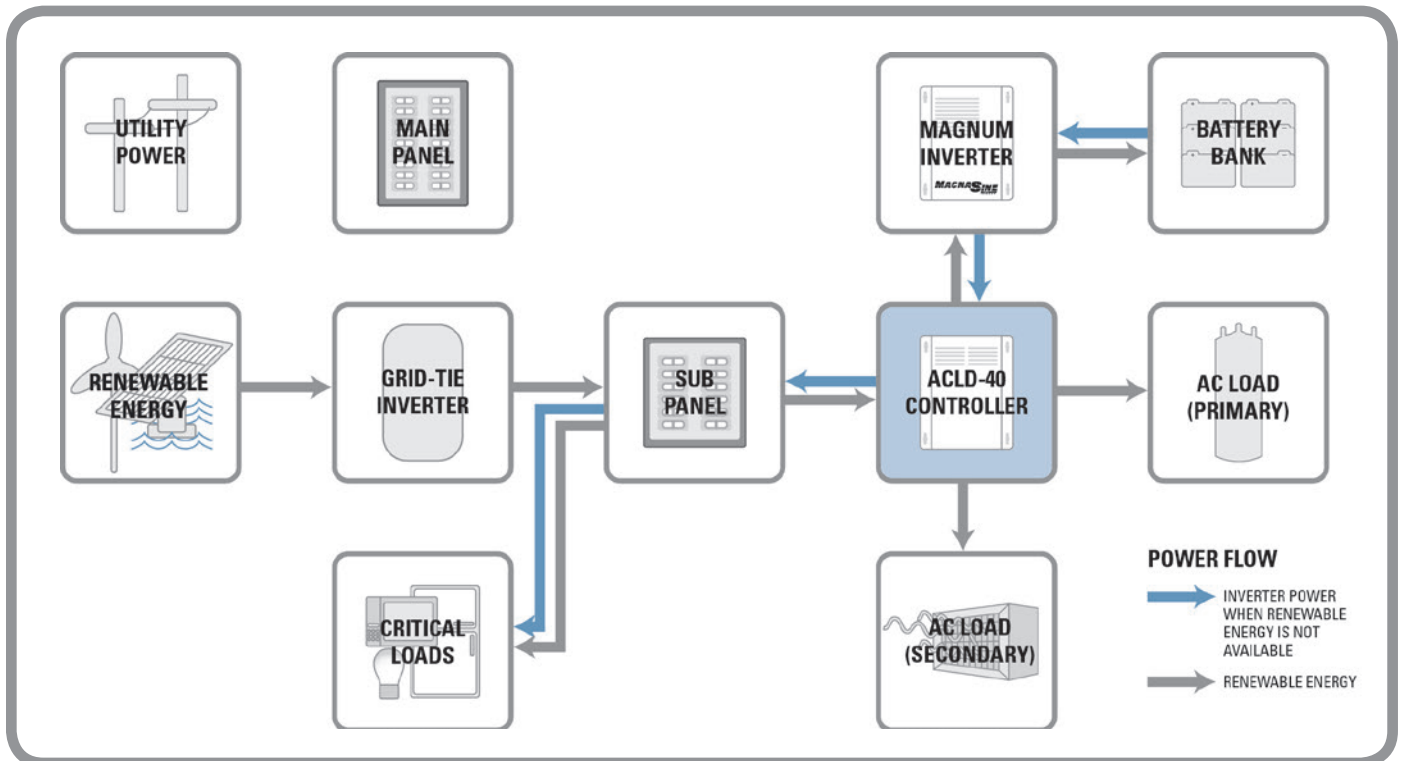

Priority of renewable power use:

- Critical loads
- Charging batteries
- Primary AC load diversion
- Secondary AC load diversion

PT-100 CHARGE CONTROLLER

Model Number
PT-100



Available For

- Renewable Energy Systems
 - Off-grid Power
 - Backup Power

Works With

	PAGE
MS Series.....	28
MS-PAE Series.....	6
MMP Panel System.....	12
MP Panel System.....	13

Available Configurations

- Works as a stand-alone controller using internal settings
- Works with a Magnum Energy brand Inverter/Charger and Magnum Energy brand Remote. Menu settings for the PT-100 are currently only available via the ME-ARC Remote.

Available Accessories

DC Breakers.....	40
------------------	----

The PT-100 is a Maximum Power Point Tracker (MPPT) charge controller designed to harvest the maximum available energy from the PV array and deliver it to the batteries. The PT-100's MPPT algorithm finds the maximum power point of the array and operates at this point while regulating the output current to 100 amps and battery voltage to fully charge the battery.

Features

- **High Efficiency:** The PT-100 provides typical 99% conversion efficiency and uses less than four watts of power in nighttime mode.
- **MPPT:** Maximum Power Point Tracking technology for increased PV power output efficiency.
- **Voltage Options:** Compatible with 12, 24, or 48V battery systems with automatic detection of system voltage. The PT-100 will produce up to 100 amps regardless of battery voltage.
- **Supports a Large PV Array:** A single controller supports a large PV array up to 6600W. Larger PV arrays may be used because the PT-100 is current limited to 100 amps for maximum harvest.
- **Optimal Battery Charging:** Automatic battery temperature compensation using an included external temperature sensor for optimum battery charging, even during extreme temperature changes.
- **Multi-stage Charging:** Maximizes system performance and improves battery life.
- **GFDI:** Integrated PV Ground-Fault Detection and Interruption/Indication, with pre-fault leakage/diagnostic metering.
- **LED Indicators and Screen:** Multiple LED indicators and large digital LED screen on front panel for easy-to-read system information.
- **On-site Updates:** The PT-100's software can be updated on site.
- **Extensive Electronic Protection:** Over-temperature protection, power derating when temperature is high, PV short circuit and high PV input shutdown, output overcurrent protection and night-time back-feed (reverse current) protection.
- **AFCI:** An integrated PV Arc-Fault Circuit Interrupter detects, indicates, and extinguishes series arcs.
- **Convenient Installation:** Run all of the wiring to the unique, remain-in-place wiring box with ease prior to installing the full PT-100 unit.
- **Easy MP and MMP integration:** The PT-100 is designed to work with a Magnum Panel (MP) or Mini-Magnum Panel (MMP). It provides room and access to PV and battery disconnect breakers.

Even More Functionality with the Optional Remote

- Built-in programmable auxiliary relay for device control.
- Internal data logging functionality keeps energy harvest information and battery Ahr/Whr data up to 255 days. Use the optional remote to display this information.

PT-100 CHARGE CONTROLLER SPECIFICATIONS

PT-100	
ELECTRICAL SPECIFICATIONS	
Maximum PV input voltage (any condition)	200 VDC + battery voltage or 240 VDC - whichever is lower
Maximum PV operating voltage	187 VDC
Maximum PV array short circuit current	100 ADC
Nominal battery voltage range	12, 24, or 48 VDC
Battery charger output voltage range	10 to 66 VDC
Continuous charger output current	100 ADC (from -20 °C to +40 °C) with proportional power reduction up to 60 °C ambient
Maximum output power	6600 watts
Efficiency	99% typical
Tare loss / nighttime power consumption	<4 watts (fan off, display/LEDs off)
Charger regulation method	Automatic three-stage (bulk, absorption, float) charge with manual equalization
GENERAL FEATURES AND CAPABILITIES	
Battery temperature compensation	With Battery Temperature Sensor (BTS) connected (battery temperature -20 °C to +55 °C)
Internal cooling	Using dual ball-bearing fans for long life
Overcurrent protection	With two overlapping circuits
Over-temperature protection	On transformer and MOSFETS
Listings	ETL Listed to UL/cUL 1741, CSA C22.2 #107.1-01, CE
Warranty	Five years parts and labor
ENVIRONMENTAL SPECIFICATIONS	
Operating temperature	-20° C to +60° C (-4° F to 140° F)
Nonoperating temperature	-40° C to +70° C (-40° F to 158° F)
Operating humidity	0 to 95% RH non condensing
PHYSICAL SPECIFICATIONS	
Enclosure type	Indoor, ventilated, with removable powder-coated conduit box
Unit dimensions (w x h x d)	8.5" x 15.5" x 4.0" (21.6 cm x 39.4 cm x 10.2 cm)
Shipping dimensions (w x h x d)	11.5" x 19.5" x 8.125" (29.2 cm x 49.5 cm x 20.6 cm)
Mounting	Mounted on a vertical surface (wall) or installed on MP or MMP enclosure
Weight	13.6 lb (6.2 kg)
Shipping weight	18 lb (8.2 kg)
Max operating altitude	15,000' (4570 m)

Testing for specifications at 25° C. Specifications subject to change without notice.

MMP – MINI MAGNUM PANEL



The MMP – Mini Magnum Panel is an inclusive, easy-to-install panel designed to work with one Magnum MS-PAE, MS, RD Series Inverter/Charger. The Panel can be configured to work with any 24 or 48 volt battery-based inverter/charger.

The MMP shown with inverter (sold separately) and optional remote and backplate.

FEATURES

Small footprint:

Only 12.5" wide x 18" tall x 8" deep.

Money-saving design:

Not only is the MMP less expensive, but it is pre-wired for fast installation, saving labor costs.

Easy access:

Front-mounted breakers and remote (optional).

Choices:

Can be wired for 120 VAC or 120/240 VAC output.

Inclusive:

Works with non-Magnum inverter / chargers (stand-alone parts included).

Listed:

ETL listed to UL1741 and CSA C22.2 107-01.

DC load breakers:

Fits either din rail or back-mount DC load breakers.



PART NUMBERS	DIMENSIONS (H X W X D)	SHIPPING WEIGHT
MMP250-30D	22" x 15" x 13" (55.9 cm x 38.1 cm x 33 cm)	32 lb (14.5 kg)
MMP250-60S	22" x 15" x 13" (55.9 cm x 38.1 cm x 33 cm)	31 lb (14.1 kg)
MMP175-30D	22" x 15" x 13" (55.9 cm x 38.1 cm x 33 cm)	32 lb (14.5 kg)
MMP175-30D	22" x 15" x 13" (55.9 cm x 38.1 cm x 33 cm)	31 lb (14.1 kg)

INCLUDES

- One DC breaker – 175A or 250A
- One AC system bypass – 30A dual pole or 60A single pole
- One AC input breaker – 30A dual pole or 60A single pole
- 500A/50mv DC shunt
- DC buss bars for battery positive and negative
- Din rail or back mount for optional DC mini breakers – will hold up to eight breakers
- Inverter hood

The MMP, including Magnum Energy brand products are covered under a five-year warranty when installed and purchased together!

MPSL - MAGNUM PANEL



The MPSL – Magnum Panel, Single Enclosure, Low Power – is designed to accommodate a maximum of two inverters.

The MPSL shown with a single inverter (sold separately) and an optional backplate.

FEATURES

Expandable:

Start with the enclosure and just one inverter and in the future expand to two inverters with ease, using the MPX.

Easy Installation:

All connections are front-mounted, including AC and DC breakers and the MPX extension kit.

Labor Saving:

Panel is pre-wired for fast installation, saving labor costs.

DC Load Breakers:

Fits either din rail or back-mount DC load breakers.

Convenient Knockouts:

Knockouts on the side of the enclosure are compatible with most charge controllers.



PART NUMBERS	DIMENSIONS (H X W X D)	SHIPPING WEIGHT
MPSL175-30D	27" x 18" x 15" (68.6 cm x 45.7 cm x 38.1 cm)	50 lb (22.7 kg)
MPSL250-30D	27" x 18" x 15" (68.6 cm x 45.7 cm x 38.1 cm)	50 lb (22.7 kg)
MPSL250-60S	27" x 18" x 15" (68.6 cm x 45.7 cm x 38.1 cm)	50 lb (22.7 kg)

The MPSL shown with two inverters (sold separately), an optional MPX extension to accommodate a second inverter, an optional dual backplate, and an optional router.

INCLUDES

- One DC breaker – 175A or 250A
- One 60A AC system bypass
- 500A/50mv DC shunt
- One inverter AC input breaker
- Inverter hood

The MPSL, including Magnum Energy brand products are covered under a five-year warranty when installed and purchased together!

See pages 14-15 for available configurations

MPSL***-30D CONFIGURATIONS

Only MPSL250-30D configurations shown below for clarity.

*** can be either 175 or 250, depending on the inverter model.
See page 20 for information on reading Magnum Panel part numbers.

MPSL250-30D (As Shipped)

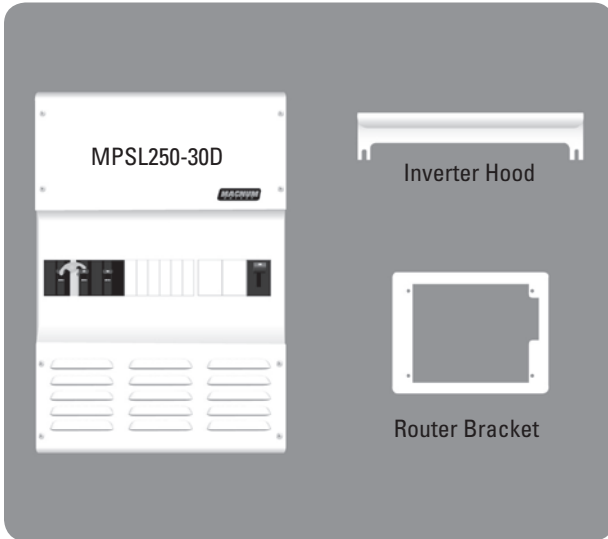

MPSL includes:

- 60A AC System Bypass
- 30A AC Inverter Input Breaker
- 250A DC Battery Disconnect
- 500A/50mV DC Shunt
- Inverter Hood
- Router Bracket

MPSL250-30D (As Field Installed)



MPSL includes:

- D60A AC System Bypass
- D30A AC Inverter Input
- 250A DC Battery Disconnect
- 500A/50mV DC Shunt
- Inverter Hood
- Router Bracket

Options shown, not included:

- MS-PAE Parallel-stack inverter preferred, but any Magnum MS/RD Series inverter – using 30 amp pass thru – can be used in this one inverter MP configuration. See MMP Series panels for additional single inverter installations.
- BP-S - mounting backplate - single

Continuous Power Output at 25 °C:

- 4kVA with one MS4024PAE
- 4.4kVA with one MS4448PAE

MPSL250-30D WITH MPXS250-30D-L

(As Field Installed)

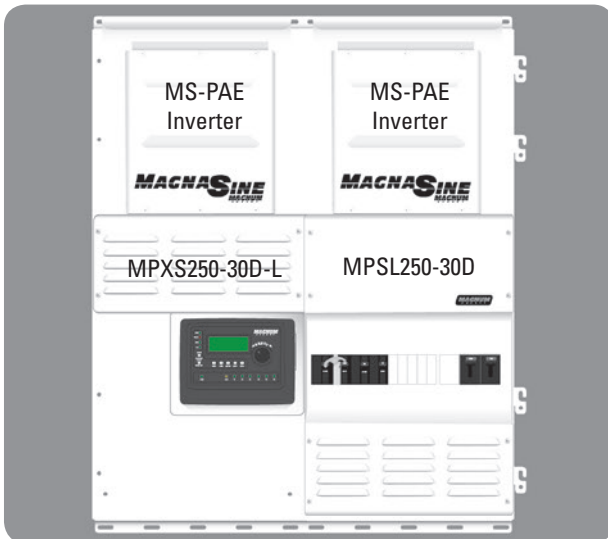

MPSL with MPX includes:

- D60A AC System Bypass
- D30A AC Inverter Inputs (x2)
- 250A DC Battery Disconnect (x2)
- 500A/50mV DC Shunt
- Inverter Hood (x2)
- Router Bracket

Options shown, not included:

- MS-PAE Parallel-stack inverter (x2)
- ME-RTR Router
- BP-D - mounting backplate - dual

Continuous Power Output at 25 °C:

- 8kVA with two MS4024PAEs
- 8.8kVA with two MS4448PAEs

MPSL250-30D WITH MPXS250-30D-R

(As Field Installed)

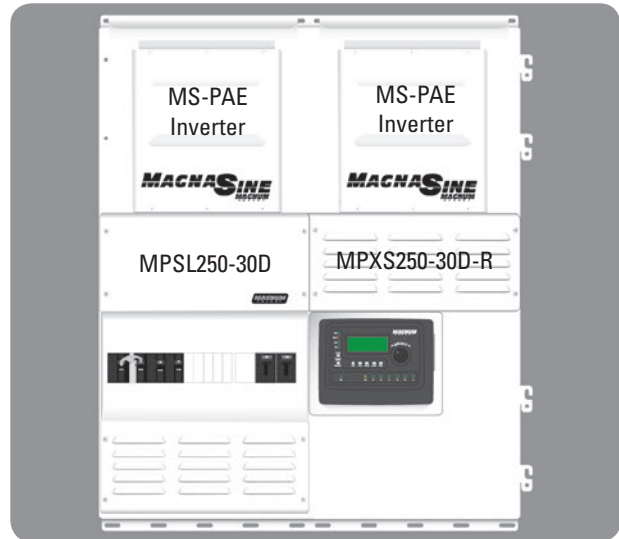

MPSL with MPX includes:

- D60A AC System Bypass
- D30A AC Inverter Inputs (x2)
- 175 or 250A DC Battery Disconnect (x2)
- 500A/50mV DC Shunt
- Inverter Hood (x2)
- Router Bracket

Options shown, not included:

- MS-PAE Parallel-stack inverter (x2)
- ME-RTR Router
- BP-D - mounting backplate - dual

Continuous Power Output at 25 °C:

- 8kVA with two MS4024PAEs
- 8.8kVA with two MS4448PAEs

MPSL250-60S CONFIGURATIONS

The MPSL250-60S is designed for use with the MS4024 with series stacking, or with an MS/RD Series using a 60 amp pass through.

MPSL250-60S (As Shipped)

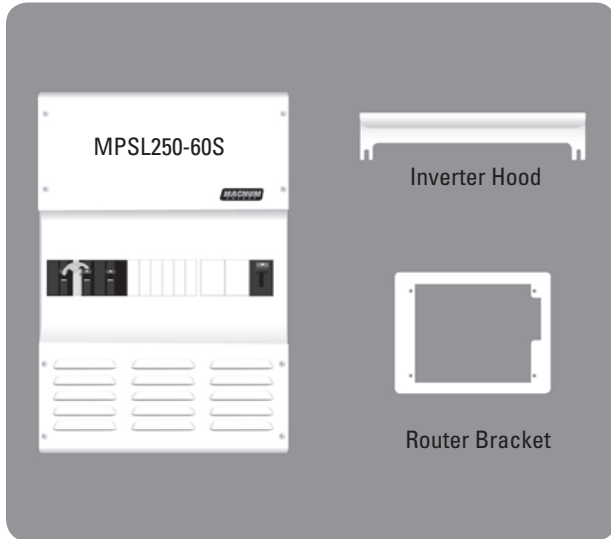

MPSL includes:

- D60A AC System Bypass
- S60A AC Inverter Input Breaker
- 250A DC Battery Disconnect
- 500A/50mV DC Shunt
- Inverter Hood
- Router Bracket

MPSL250-60S (As Field Installed)



MPSL includes:

- D60A AC System Bypass
- S60A AC Inverter Input
- 250A DC Battery Disconnect
- 500A/50mV DC Shunt
- Inverter Hood
- Router Bracket

Options shown, not included:

- MS4024 Series-stack inverter preferred, but any Magnum MS/RD Series inverter – using 60 amp pass thru – can be used in this one inverter MP configuration. See MMP Series panels for additional single inverter installations.

Continuous Power Output at 25 °C:

- 4kVA with one MS4024

- BP-S - mounting backplate - single

MPSL250-60S WITH MPXS250-60S-L (As Field Installed)



MPSL with MPX includes:

- D60A AC System Bypass
- S60A AC Inverter Inputs (x2)
- 250A DC Battery Disconnect (x2)
- 500A/50mV DC Shunt
- Inverter Hood (x2)
- Router Bracket
- Series Stacking Cable

Options shown, not included:

- MS4024 Series-stack inverter (x2)
- ME-ARC Advanced Remotes (x2)
- BP-D - mounting backplate - dual

Continuous Power Output at 25 °C:

- 8kVA with two MS4024s

MPSL250-60S WITH MPXS250-60S-R (As Field Installed)

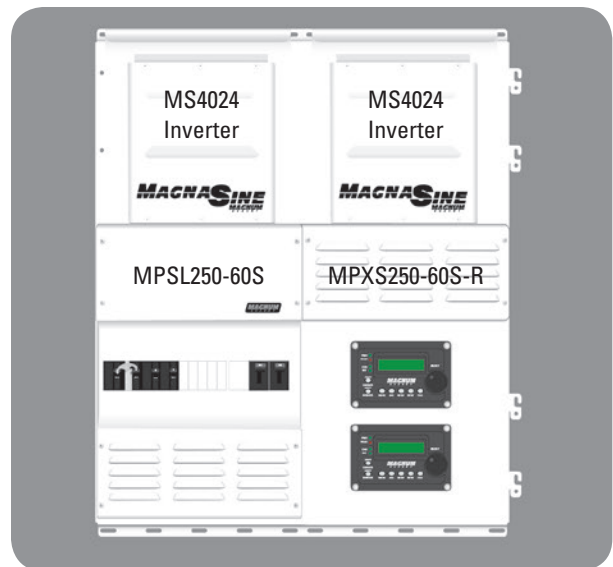

MPSL with MPX includes:

- D60A AC System Bypass
- S60A AC Inverter Inputs (x2)
- 250A DC Battery Disconnect (x2)
- 500A/50mV DC Shunt
- Inverter Hood (x2)
- Router Bracket
- Series Stacking Cable

Options shown, not included:

- MS4024 Series-stack inverter (x2)
- ME-ARC Advanced Remotes (x2)
- BP-D - mounting backplate - dual

Continuous Power Output at 25 °C:

- 8kVA with two MS4024s

MPSH – MAGNUM PANEL



The MPSH – Magnum Panel, Single Enclosure, High Power – is designed to accommodate a maximum of three inverters.

FEATURES

More power capacity:

The 125A bypass breaker and the 1000A DC shunt safely handle the power from larger systems.

Expandable:

Start with the enclosure and just one inverter and in the future expand to up to three inverters with ease, using the MPX.

Labor saving:

Panel is pre-wired for fast installation, saving labor costs.

Easy installation:

All connections are front-mounted, including AC and DC breakers and the MPX.

Convenient knockouts:

Knockouts on the side of the enclosure are compatible with charge controllers.

The MPSH shown with three inverters (sold separately), two optional MPX extensions to accommodate the additional inverters, two optional backplates, and an optional router.

PART NUMBERS	DIMENSIONS (H X W X D)	SHIPPING WEIGHT
MPSH175-30D	27" x 18" x 15" (68.6 cm x 45.7 cm x 38.1 cm)	53 lb (24.1 kg)
MPSH250-30D	27" x 18" x 15" (68.6 cm x 45.7 cm x 38.1 cm)	53 lb (24.1 kg)

INCLUDES

- One DC breaker – 175A or 250A
- One 125A AC system bypass
- 1000A/100mv DC shunt
- One inverter AC input breaker
- Inverter hood

The MP, including Magnum Energy brand products are covered under a five-year warranty when installed and purchased together!

MPSH***-30D CONFIGURATIONS

Only MPSH250-30D configurations shown below for clarity.

MPSH250-30D (As Shipped)

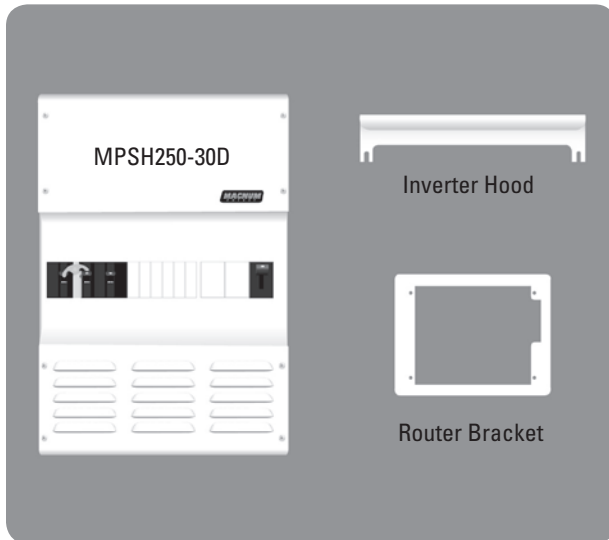

MPSH includes:

- D125A AC System Bypass
- D30A AC Inverter Input Breaker
- 250A DC Battery Disconnect
- 500A/50mV DC Shunt
- Inverter Hood
- Router Bracket

MPSH250-30D WITH MPXS250-30D-L

(As Field Installed)

*** can be either 175 or 250, depending on the inverter model. See page 20 for information on reading Magnum Panel part numbers.

MPSH250-30D WITH MPXS250-30D-L (As Field Installed)

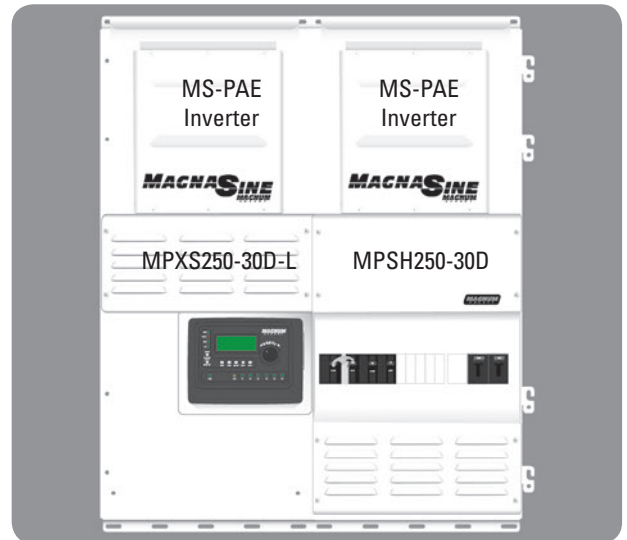

MPSH with MPX includes:

- D125A AC System Bypass
- D30A AC Inverter Input (x2)
- 250A DC Battery Disconnect (x2)
- 500A/50mV DC Shunt
- Inverter Hood (x2)
- Router Bracket

Continuous Power Output at 25 °C:

- 8kVA with two MS4024PAEs
- 8.8kVA with two MS4448PAEs

Options shown, not included:

- MS-PAE Parallel-stack inverters (x2)
- ME-RTR Router
- BP-D - mounting backplate - dual

MPSH250-30D WITH MPXS250-30D-R

(As Field Installed)

MPSH250-30D WITH MPXS250-30D-L AND MPXS250-30D-R (As Field Installed)

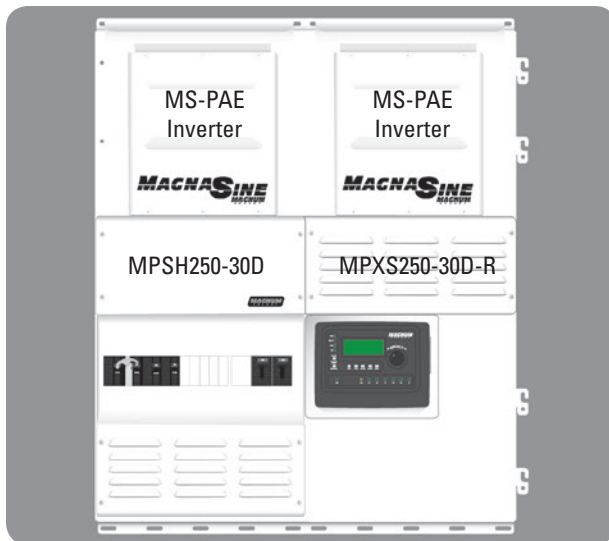

MPSH with MPX includes:

- D125A AC System Bypass
- D30A AC Inverter Input (x2)
- 250A DC Battery Disconnect (x2)
- 500A/50mV DC Shunt
- Inverter Hood (x2)
- Router Bracket

Continuous Power Output at 25 °C:

- 8kVA with two MS4024PAEs
- 8.8kVA with two MS4448PAEs

Options shown, not included:

- MS-PAE Parallel-stack inverters (x2)
- ME-RTR Router
- BP-D - mounting backplate - dual

MPSH250-30D WITH MPXS250-30D-L AND MPXS250-30D-R (As Field Installed)

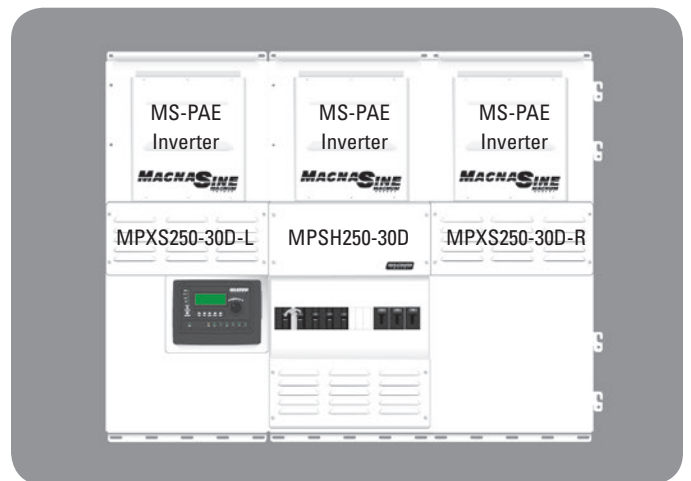

MPSH with MPX includes:

- D125A AC System Bypass
- D30A AC Inverter Input (x3)
- 250A DC Battery Disconnect (x3)
- 500A/50mV DC Shunt
- Inverter Hood (x3)
- Router Bracket

Continuous Power Output at 25 °C:

- 12kVA with three MS4024PAEs
- 13.2kVA with three MS4448PAEs

Options shown, not included:

- MS-PAE Parallel-stack inverters (x3)
- ME-RTR Router
- BP-S - mounting backplate - single
- BP-D - mounting backplate - dual

MPDH – MAGNUM PANEL



The MPDH – Magnum Panel, Dual Enclosure, High Power – is designed to accommodate a maximum of four inverters with two enclosures – one for AC connections and one for DC connections.

The MPDH shown with four inverters (sold separately), two optional MPX extensions to accommodate the additional inverters, two optional backplates, and the optional Magnum router.

FEATURES

More power capacity:

The 125A bypass breaker and the 1000A DC shunt safely handle the power from larger systems.

Expandable:

Start with the enclosures and just two inverters and in the future expand to up to four inverters, using the MPX.

Easy installation:

All connections are front-mounted, including AC and DC breakers and the MPX.

Labor saving:

Panel is pre-wired for fast installation, saving labor costs.

DC load breakers:

Fits either din rail or back-mount DC load breakers.

Convenient knockouts:

Knockouts on the side of the enclosures are compatible with charge controllers.

Separate AC and DC enclosures:

For installers who prefer separate enclosures, the MPDH provides an easy solution.

PART NUMBERS	DIMENSIONS (H X W X D)	SHIPPING WEIGHT
MPDH175-30D	MPDH175-30D-AC: 27" x 18" x 15" (68.6 cm x 45.7 cm x 38.1 cm) MPDH175-30D-DC: 27" x 18" x 15" (68.6 cm x 45.7 cm x 38.1 cm)	MPDH175-30D-AC: 46 lb (20.9 kg) MPDH175-30D-DC: 48 lb (21.8 kg)
MPDH250-30D	MPDH250-30D-AC: 27" x 18" x 15" (68.6 cm x 45.7 cm x 38.1 cm) MPDH250-30D-DC: 27" x 18" x 15" (68.6 cm x 45.7 cm x 38.1 cm)	MPDH250-30D-AC: 46 lb (20.9 kg) MPDH250-30D-DC: 48 lb (21.8 kg)

INCLUDES

- Two DC breakers – 175A or 250A
- One 125A AC system bypass
- 1000A/100mv DC shunt
- Two inverter AC input breakers
- Two inverter hoods

The MP, including Magnum Energy brand products are covered under a five-year warranty when installed and purchased together!

MPDH***-30D CONFIGURATIONS

Only MPDH250-30D configurations shown below for clarity.

*** can be either 175 or 250, depending on the inverter model. See page 20 for information on reading Magnum Panel part numbers.

MPDH250-30D (As Shipped)

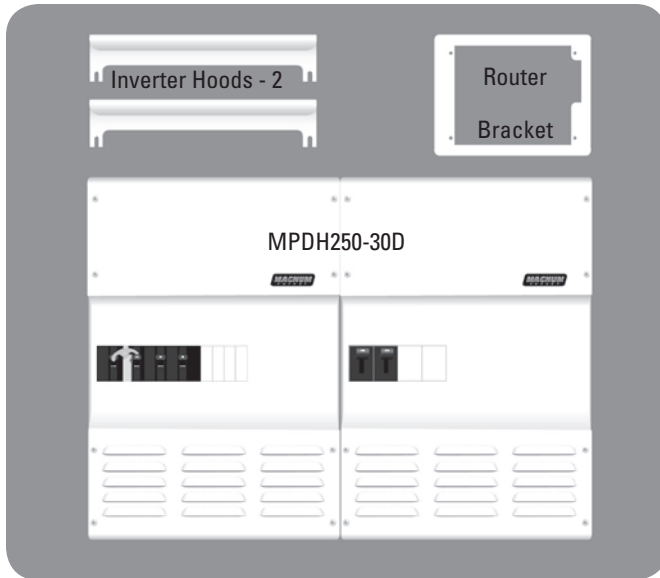

MPDH includes:

- D125A AC System Bypass
- D30A AC Inverter Input Breaker (x2)
- 250A DC Battery Disconnect (x2)
- 500A/50mV DC Shunt
- Inverter Hood (x2)
- Router Bracket

MPDH250-30D WITH MPXD250-30D-L

(As Field Installed)

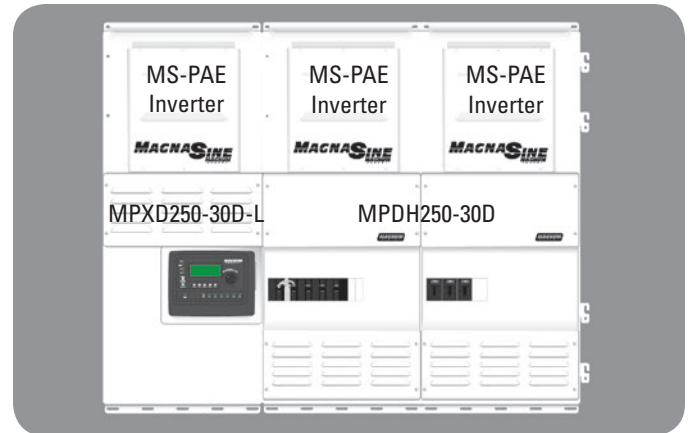

MPDH with MPX includes:

- D125A AC System Bypass
- D30A AC Inverter Input Breaker (x3)
- 250A DC Battery Disconnect (x3)
- 1000A/100mV DC Shunt
- Inverter Hood (x3)
- Router Bracket

Options shown, not included:

- MS-PAE Parallel-stack inverters (x3)
- ME-RTR Router
- BP-S - mounting backplate - single
- BP-D - mounting backplate - dual

Continuous Power Output at 25 °C:

- 12kVA with three MS4024PAEs
- 13.2kVA with three MS4448PAEs

MPDH250-30D WITH MPXD250-30D-R

(As Field Installed)

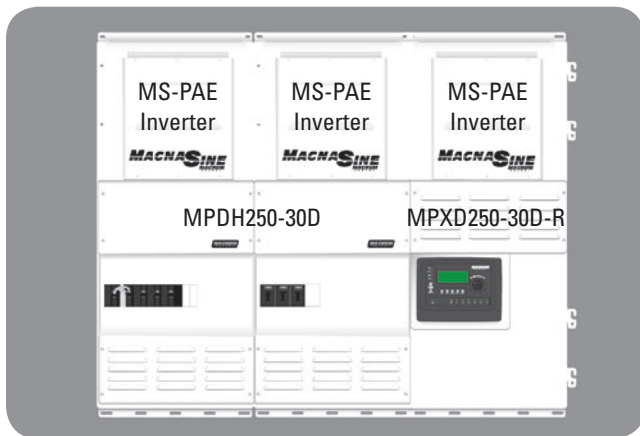

MPDH with MPX includes:

- D125A AC System Bypass
- D30A AC Inverter Input Breaker (x3)
- 250A DC Battery Disconnect (x3)
- 1000A/100mV DC Shunt
- Inverter Hood (x3)
- Router Bracket

Options shown, not included:

- MS-PAE Parallel-stack inverters (x3)
- ME-RTR Router
- BP-S - mounting backplate - single
- BP-D - mounting backplate - dual

Continuous Power Output at 25 °C:

- 12kVA with three MS4024PAEs
- 13.2kVA with three MS4448PAEs

MPDH250-30D WITH MPXD250-30D-L AND MPXD250-30D-R

(As Field Installed)

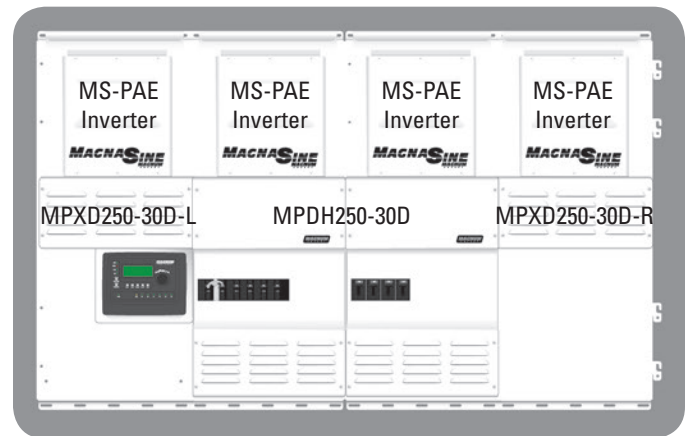

MPDH with MPX includes:

- D125A AC System Bypass
- D30A AC Inverter Input Breaker (x4)
- 250A DC Battery Disconnect (x4)
- 1000A/100mV DC Shunt
- Inverter Hood (x4)
- Router Bracket

Options shown, not included:

- MS-PAE Parallel-stack inverters (x4)
- ME-RTR Router
- BP-D - mounting backplate - dual (x2)

Continuous Power Output at 25 °C:

- 16kVA with four MS4024PAEs
- 17.6kVA with four MS4448PAEs

MAGNUM PANEL SELECTION GUIDE

STEP 1	STEP 2	STEP 3	STEP 4		STEP 5	
Continuous Power Output at 25° C	Nominal DC Input Voltage	Inverter Model	Qty	AC Wiring Configuration SISO = Single in, Single out – 120 VAC DIDO = Dual in, Dual out – 120/240 VAC	Required Panels MMP: max. 1 inverter capability MPSL: max. 2 inverter capability MPSH: max. 3 inverter capability MPDH: max. 4 inverter capability MPXS or MPXD: Expansion box, 1 unit capability	Options that allow future expansion of additional PAE inverters
2.0 kVA	12 VDC	MS2012	1	SISO-60	MMP250-60S	See page 12 NA
2.0 kVA	12 VDC	MS2012	1	DIDO	MMP250-30D	See page 12 NA
2.8 kVA	12 VDC	MS2812	1	SISO-60	MMP250-60S	See page 12 NA
2.8 kVA	12 VDC	MS2812	1	DIDO	MMP250-30D	See page 12 NA
4.0 kVA	24 VDC	MS4024	1	SISO-60	MMP250-60S	See page 12 NA
4.0 kVA	24 VDC	MS4024	1	DIDO	MMP250-30D	See page 12 NA
8.0 kVA	24 VDC	MS4024	2	SISO-60 (series stacked)	MPSL250-60S + MPXS250-60S (L/R)	See page 15 NA
4.0 kVA	24 VDC	MS4024PAE	1	DIDO	MMP250-30D	See page 12 NA
8.0 kVA	24 VDC	MS4024PAE	2	DIDO x 2	MPSL250-30D + MPXS250-30D (L/R)	See page 13 MPSH250-30D + MPXS250-30D (L/R) or MPDH250-30D
12.0 kVA	24 VDC	MS4024PAE	3	DIDO x 3	MPSH250-30D + MPXS250-30D-L + MPXS250-30D-R	See page 16 MPDH250-30D + MPXD250-30D (L/R)
16.0 kVA	24 VDC	MS4024PAE	4	DIDO x 4	MPDH250-30D + MPXD250-30D-L + MPXD250-30D-R	See page 18 NA
4.4 kVA	48 VDC	MS4448PAE	1	DIDO	MMP175-30D	See page 12 NA
8.8 kVA	48 VDC	MS4448PAE	2	DIDO x 2	MPSL175-30D + MPXS175-30D (L/R)	See page 13 MPSH175-30D + MPX175-30D (L/R) or MPDH175-30D
13.2 kVA	48 VDC	MS4448PAE	3	DIDO x 3	MPSH175-30D + MPXS175-30D-L + MPXS175-30D-R	See page 16 MPDH175-30D + MPXD175-30D (L/R)
17.6 kVA	48 VDC	MS4448PAE	4	DIDO x 4	MPDH175-30D + MPXD175-30D-L + MPXD175-30D-R	See page 18 NA

HOW TO SELECT YOUR SYSTEM COMPONENTS USING THIS CHART

- STEP 1. Select the MINIMUM required continuous output power
- STEP 2. Select DC voltage required
- STEP 3. Determine the model and number of units required
- STEP 4. Select required MP part numbers and options
- STEP 5. Select required MP part numbers if you wish to allow future expansion of the system
- STEP 6. Check to confirm AC voltage and breaker sizes are appropriate

READING MAGNUM PANEL PART NUMBERS

MAGNUM PANEL

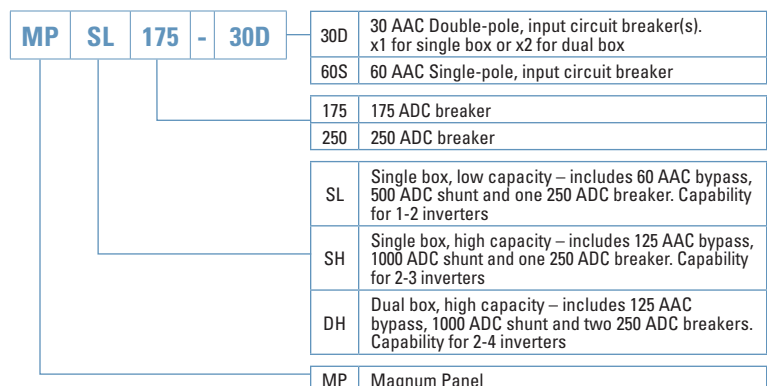

MAGNUM PANEL SELECTION GUIDE

STEP 6

OPTIONAL
FEATURES

AC Input Voltage & Frequency	Inverter AC Output Voltage & Frequency	Battery Charger Maximum Output at 25° C	AC Input / Pass-through Capacity Breaker Rating at 25° C	AC Input / Bypass with Interlock	Maximum DC Load Breakers (13mm width / back mount)
120 VAC @ 60 Hz	120 VAC @ 60 Hz	100 amps DC	S60 amps AC	S60 amps AC	8 / 4
120 / 240 VAC @ 60 Hz	120 VAC @ 60 Hz	100 amps DC	D30 amps AC	D30 amps AC	8 / 4
120 VAC @ 60 Hz	120 VAC @ 60 Hz	125 amps DC	S60 amps AC	S60 amps AC	8 / 4
120 / 240 VAC @ 60 Hz	120 VAC @ 60 Hz	125 amps DC	D30 amps AC	D30 amps AC	8 / 4
120 VAC @ 60 Hz	120 VAC @ 60 Hz	105 amps DC	S60 amps AC	S60 amps AC	8 / 4
120 / 240 VAC @ 60 Hz	120 VAC @ 60 Hz	105 amps DC	D30 amps AC	D30 amps AC	8 / 4
120 / 240 VAC @ 60 Hz	120 / 240 VAC @ 60 Hz	105 amps DC x 2	D60 amps AC	D60 amps AC	10 / 5
120 / 240 VAC @ 60 Hz	120 / 240 VAC @ 60 Hz	105 amps DC	D30 amps AC	D60 amps AC	8 / 4
120 / 240 VAC @ 60 Hz x 2	120 / 240 VAC @ 60 Hz x 2	105 amps DC x 2	D30 amps AC x 2	D60 or D 125 amps AC	10 / 5
120 / 240 VAC @ 60 Hz x 3	120 / 240 VAC @ 60 Hz x 3	105 amps DC x 3	D30 amps AC x 3	D125 amps AC	NA
120 / 240 VAC @ 60 Hz x 4	120 / 240 VAC @ 60 Hz x 4	105 amps DC x 4	D30 amps AC x 4	D125 amps AC	15 / 7
120 / 240 VAC @ 60 Hz	120 / 240 VAC @ 60 Hz	60 amps DC	D30 amps AC	D60 amps AC	8 / 4
120 / 240 VAC @ 60 Hz x 2	120 / 240 VAC @ 60 Hz x 2	60 amps DC x 2	D30 amps AC x 2	D60 or D 125 amps AC	10 / 5
120 / 240 VAC @ 60 Hz x 3	120 / 240 VAC @ 60 Hz x 3	60 amps DC x 3	D30 amps AC x 3	D125 amps AC	NA
120 / 240 VAC @ 60 Hz x 4	120 / 240 VAC @ 60 Hz x 4	60 amps DC x 4	D30 amps AC x 4	D125 amps AC	15 / 7

MAGNUM PANEL EXTENSION

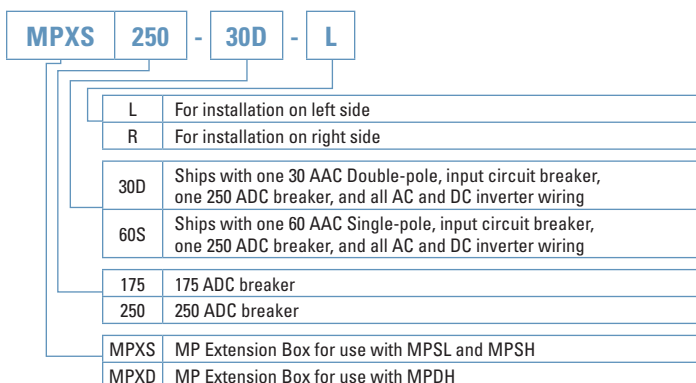

MINI MAGNUM PANEL

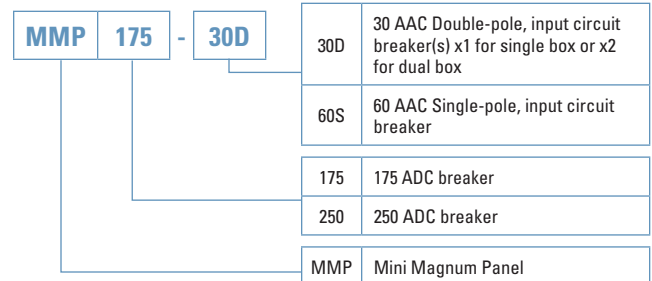

INTERCONNECTION SYSTEM EQUIPMENT ACCESSORIES

BACKPLATE FOR MMP (BP-MMP)

Model Numbers

- BP-MMP

Backplate for the MMP.
Fits one MMP only.

Works With

	PAGE
MMP Panel	12

Shipping Dimensions (h x w x d)

38" x 17" x 2" (96.5 cm x 43.2 cm x 5.1 cm)

Shipping Weight

11 lb. (5.0 kg)



BACKPLATE SINGLE (BP-S)

Model Numbers

- BP-S

Single backplate for the Magnum Panels. Fits one enclosure – MPSL, MPSH, MPXS, or MPXD.

Works With

	PAGE
MPSL	13
MPSH	16
MPXS	17
MPXD	19

Shipping Dimensions (h x w x d)

42" x 19" x 2" (106.7 cm x 88.9 cm x 5.1 cm)

Shipping Weight

18 lb (8.2 kg)



BACKPLATE DUAL (BP-D)

Model Numbers

- BP-D

Dual backplate for the Magnum Panels. Fits two enclosures – MPSL with MPX, MPSH with MPX, two MPX's, or MPDH.

Works With

	PAGE
MPSL	13
MPSH	16
MPDH	18
MPXS	17
MPXD	19

Shipping Dimensions (h x w x d)

42" x 35" x 2" (106.7 cm x 88.9 cm x 5.1 cm)

Shipping Weight

34 lb (15.5 kg)



BREAKER - AC

Model Numbers

- BR-AC30D (30A, Dual pole)
- BR-AC60S (60A, Single pole)

AC Breakers for the MP.

Works With

	PAGE
BR-AC30D	
MPSL-30D	13
MPSH-30D	16
MPDH-30D	18
BR-AC60S	
MPSL-60S	13

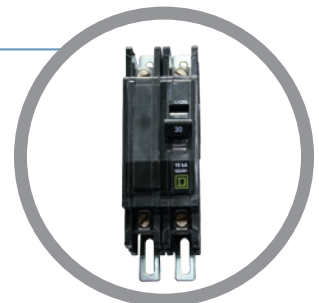

BREAKER - DC, BACK MOUNT

Model Numbers

- BR-DC75-BM
- BR-DC100-BM

Back mount DC breaker for the MMP and MP Series.

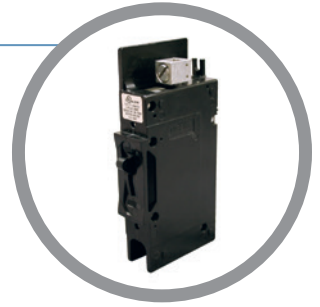

Works With

PAGE

MMP Panel	12
MPSL	13
MPSH	16
MPDH.....	18
MPXS	17
MPXD	19

BREAKER - DC, HIGH CAPACITY

Model Numbers

- BR-DC175
- BR-DC250

DC disconnect breaker for the MMP and MP Series.

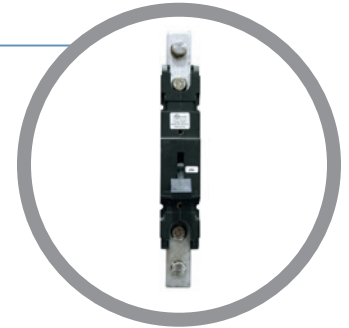

Works With

PAGE

MMP Panel	12
MPSL.....	13
MPSH.....	16
MPDH.....	18
MPXS	17
MPXD	19

Looking for DC Breakers to use with the PT100 Charge Controller? Check page 40 for a product description.

MPX SERIES

MODEL NUMBERS	INCLUDES	WORKS WITH	PAGE
MPXS175-30D-L	DC/AC breaker and wires, MP-Hood	MPSL175-30D	13
		MPSH175-30D	16
MPXS250-30D-L	DC/AC breaker and wires, MP-Hood	MPSL250-30D	13
		MPSH250-30D	16
MPXS175-30D-R	DC/AC breaker and wires, MP-Hood	MPSL175-30D	13
		MPSH175-30D	16
MPXS250-30D-R	DC/AC breaker and wires, MP-Hood	MPSL250-30D	13
		MPSH250-30D	16
MPXS250-60S-R	DC/AC breaker and wires, MP-Hood, series cables	MPSL250-60S	13
MPXS250-60S-R	DC/AC breaker and wires, MP-Hood, series cables	MPSL250-60S	13
MPXD175-30D-L	DC/AC breaker and wires, MP-Hood, parallel cables	MPDH175-30D	18
MPXD250-30D-L	DC/AC breaker and wires, MP-Hood, parallel cables	MPDH250-30D	18
MPXD175-30D-R	DC/AC breaker and wires, MP-Hood, parallel cables	MPDH175-30D	18
MPXD-250-30D-R	DC/AC breaker and wires, MP-Hood, parallel cables	MPDH250-30D	18



Extension box for use with the MP system. Each MPX fits one MS-PAE.

Dimensions (h x w x d)

27.9 cm x 50.8 cm x 30.5 cm

Shipping Weight

9.5 kg (21 lb)

ROUTER FRONT COVER - MP-RFC

Model Numbers

- MP-RFC

Note: The MP-RFC is only available for those versions of the MP enclosure that have the middle eight truss head screws.

The Router Front Cover (MP-RFC) replaces the factory-installed top front cover of an MP enclosure, allowing the ME-RTR (router) to attach to the front of an MP enclosure.

MM-AE SERIES INVERTER/CHARGER



Model Numbers

MM612AE • MM1512AE • MM1524AE



Modified Sine Wave



Battery Voltage Options



Continuous Output Options
in Watts

Available For

- Renewable Energy Systems
- Off-grid Power
- Backup Power

Available Accessories

	PAGE
Battery Monitor Kit	38
Fuse Blocks	41
MagWeb	42
Remote - ME-ARC	45
Remote - ME-RC	46

The MM-AE Series Inverter / Charger is a modified sine wave inverter providing a cost effective solution for those with smaller power needs. Versatile, easy-to-use, and lightweight, the MM-AE Series provides a reliable base for your energy system.

Power Factor Corrected (PFC) Charger: Our PFC charger is built into all of our inverter/chargers. It uses less energy from a generator than a standard charger – using 25-30% less AC current than standard chargers.

Attractive styling: The modern, hourglass case, paired with the die cast aluminum base combines form with function, creating an attractive unit that uses its base as a heat sink for superior high temperature operation.

FEATURES

Standard transfer relay:

The standard 20 amp transfer relay will pass AC power through the inverter when using grid or generator power.

Versatile mounting:

Mount the MM-AE Series on a shelf, wall, or even upside down.

Fan cooled:

The MM-AE Series is fan cooled, enabling the unit to work well in confined spaces. If the inverter does exceed its temperature limits, it will automatically shut down and then restart when it cools down.

Low battery protection:

If your battery voltage goes below the cut-out setting, the MM-AE Series will automatically shut down, saving your batteries.

High battery protection:

If your battery voltage reaches over the cut-out setting, the MM-AE Series will shut down.

Current overload protection:

The MM-AE Series will automatically shut down if its output wattage is exceeded or it detects a short in the wiring, saving the unit from costly damage.

Convenient switches:

The MM-AE Series comes with an on/off front-mounted switch and an easy-to-read LED indicator.

Circuit breaker protection:

Every model comes with built in input and output circuit breakers for ease of installation.

Battery temp sensor:

The standard battery temp sensor monitors temperatures from 0 - 50° C.

Buy with ease:

The MM-AE Series is backed by a two-year (24-month) parts and labor warranty.

MM-AE SERIES INVERTER/CHARGER SPECIFICATIONS

	MM612AE	MM1512AE	MM1524AE
INVERTER SPECIFICATIONS			
Input battery voltage range	9 to 16 VDC	9 to 16 VDC	18 to 32 VDC
Nominal AC output voltage	120 VAC ± 5%	120 VAC ± 5%	120 VAC ± 5%
Output frequency and accuracy	60 Hz ± 0.1 Hz	60 Hz ± 0.1 Hz	60 Hz ± 0.1 Hz
1 msec surge current (amps AC)	27	42	45
100 msec surge current (amps AC)	11	23	24
5 sec surge power (real watts)	1100	2100	2650
30 sec surge power (real watts)	1000	1750	2500
5 min surge power (real watts)	950	1550	2350
30 min surge power (real watts)	675	1525	1900
Continuous power output at 25° C (with 1.0 PF)	600 VA	1500 VA	1500VA
Continuous current output	5 ACC	10 ACC	13 ACC
Maximum input battery current	80 ADC	200 ADC	100 ADC
Inverter efficiency (peak)	95%	95%	91%
Transfer time	16 msecs	16 msecs	16 msecs
Search mode (typical)	3 watts	6 watts	4 watts
No load (120 VAC output, typical)	10 watts	18 watts	9 watts
Waveform	Modified Sine Wave	Modified Sine Wave	Modified Sine Wave
CHARGER SPECIFICATIONS			
Continuous output at 25° C	30 ADC	70 ADC	35 ADC
Charger efficiency	85%	88%	88%
Power factor	> 0.95	> 0.95	> 0.95
Input current at rated output (AC amps)	4	9	9
GENERAL FEATURES AND CAPABILITIES			
Transfer relay capability	20 AAC (input current for charging and pass through)		
Battery temperature compensation	Yes, 15 ft Battery Temp Sensor standard		
Internal cooling	0 to 59 cfm variable speed		
Overcurrent protection	Yes, with two overlapping circuits		
Overtemperature protection	Yes, on transformer and MOSFETS		
On/Off with status indicator	Yes, front mounted and easily accessible		
Low battery cutout	10 or 20 VDC, adjustable on most models with the ME-RC remote		
AC output/AC input	Hardwire	Hardwire	Hardwire
Output circuit breaker/Input circuit breaker	7A / 8AAC	15A / 20AAC	15A / 20AAC
Listings	NA		
Warranty	Two years		
ENVIRONMENTAL SPECIFICATIONS			
Temperature (Operating/Non-operating)	-20° C to +60° C (-4° F to 140° F) to -40° C to +70° C (-40° F to 158° F)		
Operating humidity	0 to 95% RH non-condensing		
PHYSICAL SPECIFICATIONS			
Dimensions (l x w x h)	16.6" x 8.4" x 4.7" (42 cm x 21 cm x 12 cm)		
Mounting	Shelf (top or bottom up) or wall (vents up)		
Weight	16 lb (7.3 kg)	22 lb (10 kg)	22 lb (10 kg)
Shipping weight	18 lb (8.2 kg)	24 lb (10.9 kg)	24 lb (10.9 kg)
Max operating altitude	15,000' (4570 m)		
Construction	ABS plastic top and cast aluminum bottom		

Testing for specifications at 25° C. Specifications subject to change without notice.

MMS SERIES INVERTER/CHARGER

Model Numbers
MMS1012 • MMS1012-G



Pure Sine Wave



Battery Voltage Options



Continuous Output Options
in Watts

The MMS Series Inverter / Charger is a pure sine wave inverter providing a cost effective solution for those with smaller power needs in mobile applications. Versatile, easy-to-use, and lightweight, the MMS Series provides a reliable base for your energy system.

Power Factor Corrected (PFC) Charger: Our PFC charger is built into all of our inverter/chargers. It uses less energy from a generator than a standard charger – using 25-30% less AC current than standard chargers.

Safe and reliable: The MMS Series has met the stringent requirements and is listed to UL1741 for home/office use, as well as UL/cUL 458 and CSA C22.2 #107.1-01 for mobile use.

Attractive styling: The modern, hourglass case, paired with the die cast aluminum base combines form with function, creating an attractive unit that uses its base as a heat sink for superior high temperature operation.

Available For

- Backup power
- Emergency Vehicles
- Marine Systems
- RV Systems

Available Accessories

	PAGE
DC Load Disconnect.....	41
Fuse Blocks.....	41
MagWeb.....	42
Remote - ME-ARC.....	45
Remote - ME-RC.....	46
Remote - MM-RC.....	46

FEATURES

Standard transfer relay:

The standard 20 amp transfer relay will pass AC power through the inverter when using shore or generator power.

Low/high battery protection:

If your battery voltage reaches below 10 VDC or above 17 VDC, the MMS Series will automatically shut down.

Versatile mounting:

Mount the MMS Series on a shelf, bulkhead, or even upside down.

Fan cooled:

The MMS Series is fan cooled, enabling the unit to work well in confined spaces. If the inverter does exceed its temperature limits, it will automatically shut down and then restart when it cools down.

Current overload protection:

The MMS Series will auto-matically shut down if its output wattage is exceeded or

it detects a short in the wiring, saving the unit from costly damage.

Convenient switches:

The MMS Series comes with an on/off front-mounted switch with an easy-to-read LED indicator.

Circuit breaker protection:

This model comes with built in input and output circuit breakers for ease of installation.

Battery temp sensor:

The standard battery temp sensor monitors temperatures from 0 - 50° C.

Buy with ease:

The MMS Series is backed by a two-year (24-month) parts and labor warranty.

MMS SERIES SPECIFICATIONS

	MMS1012	MMS1012-G
INVERTER SPECIFICATIONS		
Input battery voltage range	9 to 17 VDC	9 to 17 VDC
Nominal AC output voltage	120 VAC \pm 5%	120 VAC \pm 5%
Output frequency and accuracy	60 Hz \pm 0.1 Hz	60 Hz \pm 0.1 Hz
Total Harmonic Distortion (THD)	< 5%	< 5%
1 msec surge current (amps AC)	38	38
100 msec surge current (amps AC)	21	21
5 sec surge power (real watts)	1750	1750
30 sec surge power (real watts)	1600	1600
5 min surge power (real watts)	1200	1200
30 min surge power (real watts)	1050	1050
Maximum continuous input current	133 ADC	133 ADC
Inverter efficiency (peak)	87%	87%
Transfer time	16 msec	16 msec
Search mode (typical)	5 watts	5 watts
No load (120 VAC output, typical)	19 watts	19 watts
Waveform	Pure Sine Wave	Pure Sine Wave
CHARGER SPECIFICATIONS		
Continuous output at 25° C	50 ADC	50 ADC
Charger efficiency	84%	84%
Power factor	> .95	> .95
Input current at rated output (AC amps)	7	7
GENERAL FEATURES AND CAPABILITIES		
Transfer relay capability	20 AAC (input current for charging and pass through)	
Battery temperature compensation	Yes, 15 ft Battery Temp Sensor standard	
Internal cooling	0 to 59 cfm variable speed	
Overcurrent protection	Yes, with two overlapping circuits	
Overtemperature protection	Yes, on transformer and MOSFETS	
On/Off with status indicator	Yes, front mounted and easily accessible	
Low battery cutout	10 VDC, adjustable with the ME-RC remote	
AC output/AC input	Hardwire/Hardwire	Hardwire/3 ft cord
Output circuit breaker/Input circuit breaker	15A/20AAC	NA/20AAC
Listings	ETL Listed to UL/cUL458, CSA C22.2 #107.1-01, meets KKK-A-1822E standard Listed to UL 1741 for home/office use	
Warranty	Two years	
ENVIRONMENTAL SPECIFICATIONS		
Temperature (Operating/Non-operating)	-20° C to +60° C (-4° F to 140° F) to -40° C to +70° C (-40° F to 158° F)	
Operating humidity	0 to 95% RH non-condensing	
PHYSICAL SPECIFICATIONS		
Dimensions (l x w x h)	16.6" x 8.4" x 4.7" (42 cm x 21 cm x 12 cm)	
Mounting	Shelf (top or bottom up) or bulkhead (vents up)	
Weight	23 lb (10.4 kg)	
Shipping weight	25 lb (11.3 kg)	
Max operating altitude	15,000' (4570 m)	
Construction	ABS plastic top and cast aluminum bottom	

Testing for specifications at 25° C. Specifications subject to change without notice.

MS SERIES INVERTER/CHARGER



Model Numbers

MS2012 • MS2024 • MS2812 • MS4024 and MS4048 (series stackable)



Pure Sine Wave



Battery Voltage Options



Continuous Output Options in Watts

Available For

- Renewable Energy Systems
- Off-Grid Power
- Backup Power

Available Accessories

	PAGE
AGS.....	36
Battery Monitor Kit	38
Conduit Box.....	40
DC Load Disconnect.....	41
Fuse Blocks.....	41
MagWeb.....	42
MMP Panels	12
MP Panels (MS4024 only)	13
PT-100 Charge Controller.....	10
Remote - ME-ARC.....	45
Remote - ME-RC.....	46
Remote Switch Adapter.....	47
Series Stacking	
Interface (MS4024 and MS4048 only).....	47

New features available using the ME-ARC (with v5.4 or higher firmware).

The Magnum Energy brand MS Series Inverter/Charger from Sensata Technologies – a pure sine wave inverter designed specifically for the most demanding mobile, backup, and off-grid applications. The MS Series Inverter/Charger is powerful, easy-to-use, and best of all, cost effective.

Power Factor Corrected (PFC) Charger: Our PFC charger is built into all of our inverter/chargers. It uses less energy from a generator than a standard charger – using 25-30% less AC current than standard chargers.

Safe and reliable: The MS2012, MS2812, MS4024 and MS4048 are ETL Listed to the stringent requirements of UL 1741 and CSA C22.2 #107.1-01 for renewable energy installations.

Easy-to-install: Install the MS Series in four easy steps: simply connect the inverter’s output to your distribution circuits or electrical panel, connect your utility power cable to the inverter’s easy-to-reach terminal block, connect the batteries, and switch on the power.

FEATURES

Pure Sine Wave:

Power your TVs, stereos, plasma screens, and other sensitive electronics without worry. The pure sine wave inverter and power factor corrected charger provide clean, reliable inverter power with low total harmonic distortion (THD) of less than 5%.

Accessible Design:

The extra large AC access cover with terminal screw block and 360° DC connection terminals with covers make this inverter more accessible when it needs to be.

Choices:

The MS Series comes in 12, 24 and 48 volt configurations, allowing you to choose the model that is right for you.

Versatile Mounting:

Mount the MS Inverter/Charger on a shelf, wall, or even upside down.

Lightweight:

The lightweight aluminum base and cover also provides noise reduction and corrosion resistance.

Multiple Ports:

The MS Series provides multiple ports, including an RS485 communication port for network expansion, and a remote port.

Convenient Switches:

The MS Series comes with an on/off inverter-mounted switch with an easy-to-read LED indicator.

Expanded Transfer Relay:

60 Amp transfer service is available on all models.

Buy with Ease:

The MS Inverter/Charger is backed by a three-year (36-month) limited warranty.

MS SERIES INVERTER/CHARGER SPECIFICATIONS

	MS2012	MS2812	MS2024	MS4024	MS4048 MS4048-20B
INVERTER SPECIFICATIONS					
Input battery voltage range	9 - 16.8 VDC	9 - 16.8 VDC	18 - 33.6 VDC	9 - 33.6 VDC	36 - 67.6 VDC
AC output voltage accuracy	120 VAC ± 5%	120 VAC ± 5%	120 VAC ± 5%	120 VAC ± 5%	120 VAC ± 5%
Output frequency and accuracy	60 Hz ± 0.1 Hz	60 Hz ± 0.1 Hz	60 Hz ± 0.1 Hz	60 Hz ± 0.1 Hz	60 Hz ± 0.1 Hz
Total Harmonic Distortion (THD)	< 5%	< 5%	< 5%	< 5%	< 5%
1 msec surge current (amps AC)	50	70	75	120	120
100 msec surge current (amps AC)	33	40	37	82	72
5 sec surge power (real watts)	3300	3900	2850	5800	8500
30 sec surge power (real watts)	3100	3800	2750	5400	5750
5 min surge power (real watts)	2800	3200	2700	4900	5250
30 min surge power (real watts)	2200	3000	2200	4500	47500
Maximum continuous input current	267 ADC	373 ADC	133 ADC	267 ADC	133 ADC
Inverter efficiency (peak)	90.6%	90%	86%	93.7%	94%
AC Relay Transfer time (minimum)	16 msec	16 msec	16 msec	16 msec	16 msec
Power Consumption - searching	<8 watts	<8 watts	<8 watts	<8 watts	<8 watts
Power Consumption - inverting (no load)	25 watts	30 watts	25 watts	25 watts	25 watts
Output Waveform	Pure Sine Wave	Pure Sine Wave	Pure Sine Wave	Pure Sine Wave	Pure Sine Wave
CHARGER SPECIFICATIONS					
Continuous output at 25° C	100 ADC	125 ADC	60 ADC	105 ADC	60 ADC
Charger efficiency	85%	85%	85%	85%	85%
Power factor	> .95	> .95	> .95	> .95	> .95
Input current for continuous rated output	15 AAC	18 AAC	7.9 AAC	29 AAC	30 AAC
GENERAL FEATURES AND CAPABILITIES					
Transfer relay capability	30 ACC max. each input (30AC total on MS2000 models, 60ACC total on all other models)*				
Five stage charging capability	Bulk, Absorb, Float, Equalize (requires remote), and Battery Saver™				
Battery temperature compensation	Standard with available temp sensor connected (battery temp 0-50° C)				
Internal cooling	0 to 120 cfm variable speed drive using dual 92mm brushless DC fans				
Overcurrent protection	Yes, with two overlapping circuits				
Overtemperature protection	Yes on transformer, MOSFETS, and battery				
Corrosion protection	Yes, PCB's conformal coated, powder coated chassis/top, and stainless steel fasteners				
Safety listings	ETL Listed to UL 1741, CSA C22.2 #107.1-01				
Warranty	Three years parts and labor				
ENVIRONMENTAL SPECIFICATIONS					
Temperature (Operating/Non-operating)	-20° C to +60° C (-4° F to 140° F) to -40° C to +70° C (-40° F to 158° F)				
Operating humidity	0 to 95% RH non-condensing				
PHYSICAL SPECIFICATIONS					
Dimensions (l x w x h)	13.75" x 12.65" x 8.0" (34.9 cm x 32.1 cm x 20.3 cm) [Height on MS2000: 7.0"/17.8 cm]				
Mounting	Shelf or wall (vents not allowed to face downward unless ME-CB or MMP/MP is installed)				
Unit weight	42 lb (19.1 kg)	55 lb (24.9 kg)	41 lb (18.6 kg)	55 lb (24.9 kg)	55 lb (24.9 kg)
Shipping weight	48 lb (21.8 kg)	62 lb (28.1 kg)	49 lb (22.2 kg)	62 lb (28.1 kg)	62 lb (28.1 kg)
Max operating altitude	15,000' (4570 m)				

Testing for specifications at 25° C. Specifications subject to change without notice.

MSH-RE SERIES INVERTER / CHARGER



Model Number
MSH4024RE



Pure Sine Wave



Battery Voltage Options



Continuous Output Options
in Watts

Available For

- Renewable Energy Systems
Off-grid Power
Backup Power

Available Accessories

	PAGE
AGS.....	36
Battery Monitor Kit.....	38
Conduit Box.....	40
DC Load Disconnect.....	40
Fuse Blocks.....	41
MagWeb.....	42
MMP Panels.....	12
PT-100 Charge Controller.....	10
Remote - ME-ARC*.....	45
Remote - ME-RC*.....	46
Remote Switch Adapter.....	47

New Warranty

- Three-year warranty standard.
Five-year warranty if purchased with
and installed on an MMP panel.

*New status displays require ME-RC v2.7
or ME-ARC v3.0 or higher.

The MSH-RE Series Inverter / Charger from Sensata Technologies – a pure sine wave inverter that combines the tried and tested engineering of Sensata’s MS line with hybrid technology to make it an optimal choice for your renewable and backup power needs.

Hybrid technology: Most inverters only use one source of energy to power loads, either from incoming AC power – utility or AC generator – or from the batteries. The MSH-RE Series combines the energy from both sources to power loads. This allows the inverter to recharge the batteries when there is surplus power or deliver more power to the loads if they require more than the AC input can supply by itself.

Load support: Load support parallels the inverter output with incoming AC sources allowing it to run larger loads from smaller generators.

FEATURES:

Pure sine wave:

Power your T.V.s, stereos, plasma screens, and other sensitive electronics without worry. The pure sine wave inverter and power factor corrected charger provide clean, reliable inverter power with low total harmonic distortion (THD) of less than 5%.

Easy-to-install:

Install the MSH-RE Series in four easy steps: simply connect the inverter’s output to your distribution circuits or electrical panel, connect your utility power cable to the inverter’s easy-to-reach terminal block, connect the batteries, and switch on the power.

Dual AC inputs:

The MSH-RE Series comes with two 60 amp AC inputs – a grid input at 60A and a generator input at 60A.

Accessible design:

The extra large AC access cover with terminal screw block and 360° DC connection terminals with covers make this inverter more accessible when it needs to be.

Interchangeable:

The MSH-RE is interchangeable with the Magnum MS Series and uses the same accessories as the MS Series.

Lightweight:

The lightweight aluminum base and cover also provides noise reduction and corrosion resistance.

Multiple ports:

The MSH-RE Series provides multiple ports, including an RS485 communication port for network expansion, and a remote port.

Convenient switches:

The MSH-RE Series comes with an on/off inverter-mounted switch with an easy-to-read LED indicator.

Buy with ease:

The MSH-RE Series is backed by a three-year (36-month) limited warranty, and a five-year limited warranty when installed on an MMP system.

MSH-RE SERIES SPECIFICATIONS

MSH4024RE	
INVERTER SPECIFICATIONS	
Input battery voltage range	18 - 34 VDC
Nominal AC output voltage	120 VAC \pm 3%
Output frequency and accuracy	60 Hz \pm 0.05 Hz
Total Harmonic Distortion (THD)	< 5%
1 msec surge current (amps AC)	120
100 msec surge current (amps AC)	82
5 sec surge power (real watts)	5800
30 sec surge power (real watts)	5400
5 min surge power (real watts)	4900
30 min surge power (real watts)	4500
Continuous power output at 25° C	4000 VA
Maximum continuous input current	267 ADC
Inverter efficiency (peak)	93.7%
Transfer time	< 16 msec
Search mode (typical)	< 7 watts
No load (120 VAC output, typical)	25 watts
Waveform	Pure Sine Wave
CHARGER SPECIFICATIONS	
Continuous output at 25° C	110 ADC
Charger efficiency	85%
Power factor	> .95
Input current at rated output (AC amps)	29
GENERAL FEATURES AND CAPABILITIES	
Transfer relay capability	60 AAC maximum each input
Five stage charging capability	Bulk, Absorb, Float, Equalize (requires remote), and Battery Saver™
Battery temperature compensation	Standard with available temp sensor connected (battery temp 0 - 50 °C)
Internal cooling	0 to 120 cfm variable speed drive using dual 92mm brushless DC fans
Overcurrent protection	Yes, with two overlapping circuits
Overtemperature protection	Yes on transformer, MOSFETS, and battery
Corrosion protection	Yes, PCB's conformal coated, powder coated chassis/top, and stainless steel fasteners
Dual AC branch rated output breakers	No
Listings	ETL listed to UL/cUL 1741, CSA C22.2 No. 107.1-01
Warranty	Three years parts and labor
ENVIRONMENTAL SPECIFICATIONS	
Temperature (Operating/Non-operating)	-20° C to +60° C (-4° F to 140° F) to -40° C to +70° C (-40° F to 158° F)
Operating humidity	0 to 95% RH non-condensing
PHYSICAL SPECIFICATIONS	
Dimensions (l x w x h)	13.75" x 12.65" x 8.0" (34.9 cm x 32.1 cm x 20.3 cm)
Shipping dimensions (l x w x h)	19" x 17" x 13" (48.3 cm x 43.2 cm x 33 cm)
Mounting	Shelf or wall (vents not allowed to face downward unless ME-CB or MMP is installed)
Weight	58 lb (26.3 kg)
Shipping weight	60 lb (27.2 kg)
Max operating altitude	15,000' (4570 m)

Testing for specifications at 25° C. Specifications subject to change without notice.

MSH-RE SERIES INVERTER / CHARGER

MSH-RE SERIES HYBRID TECHNOLOGY STEP-BY-STEP

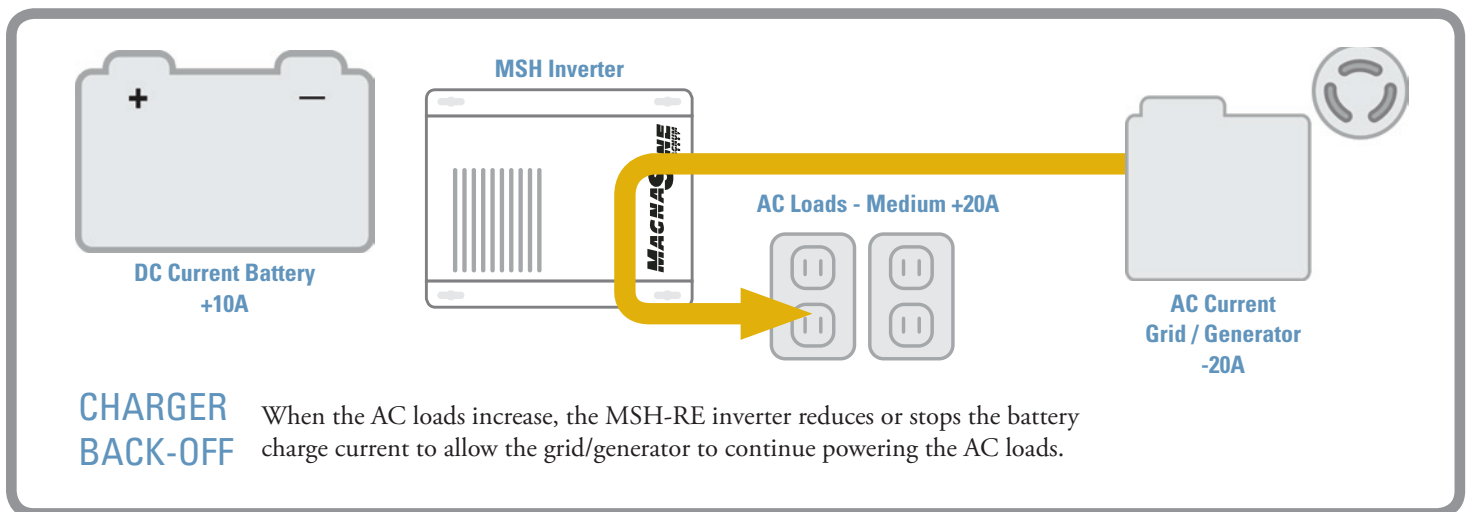
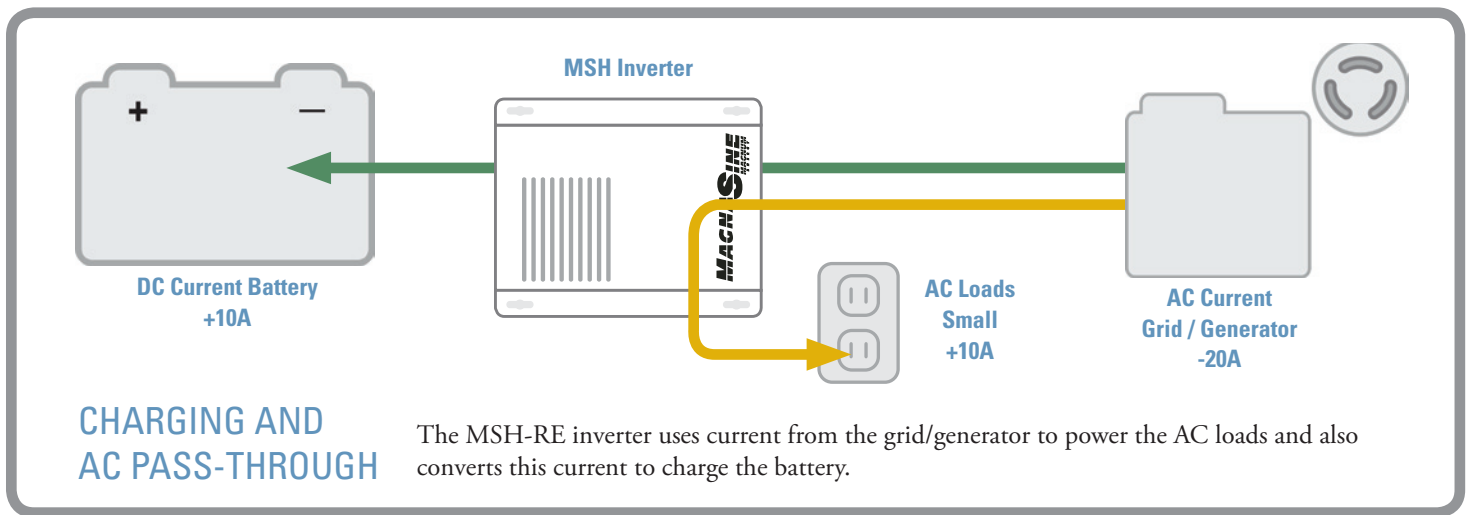
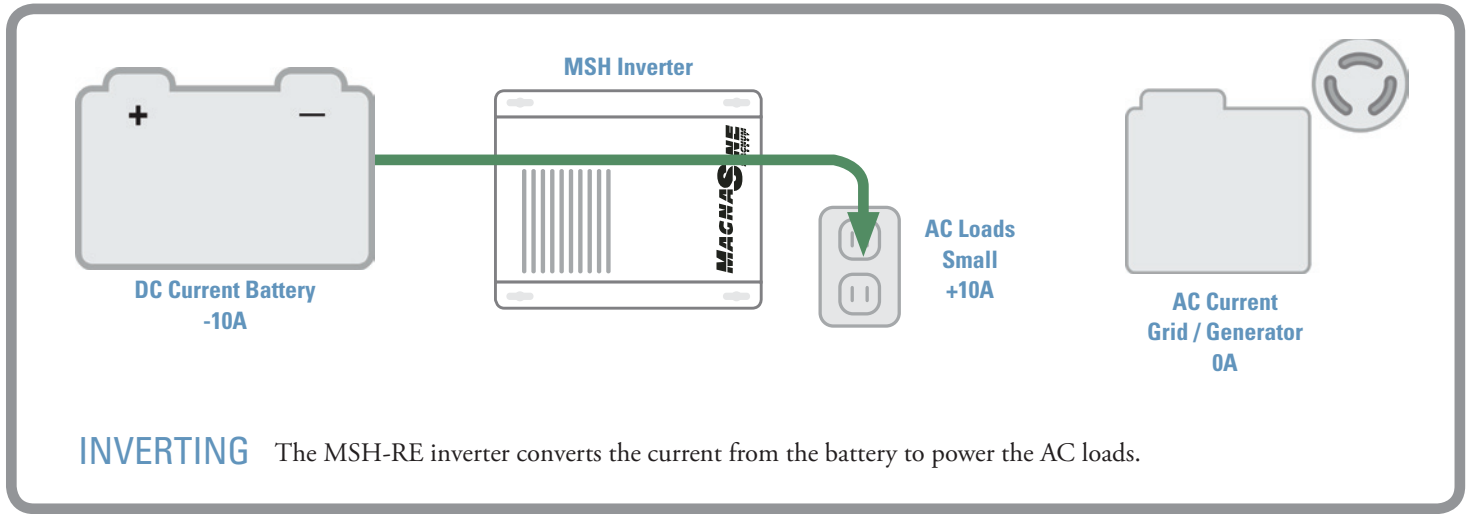

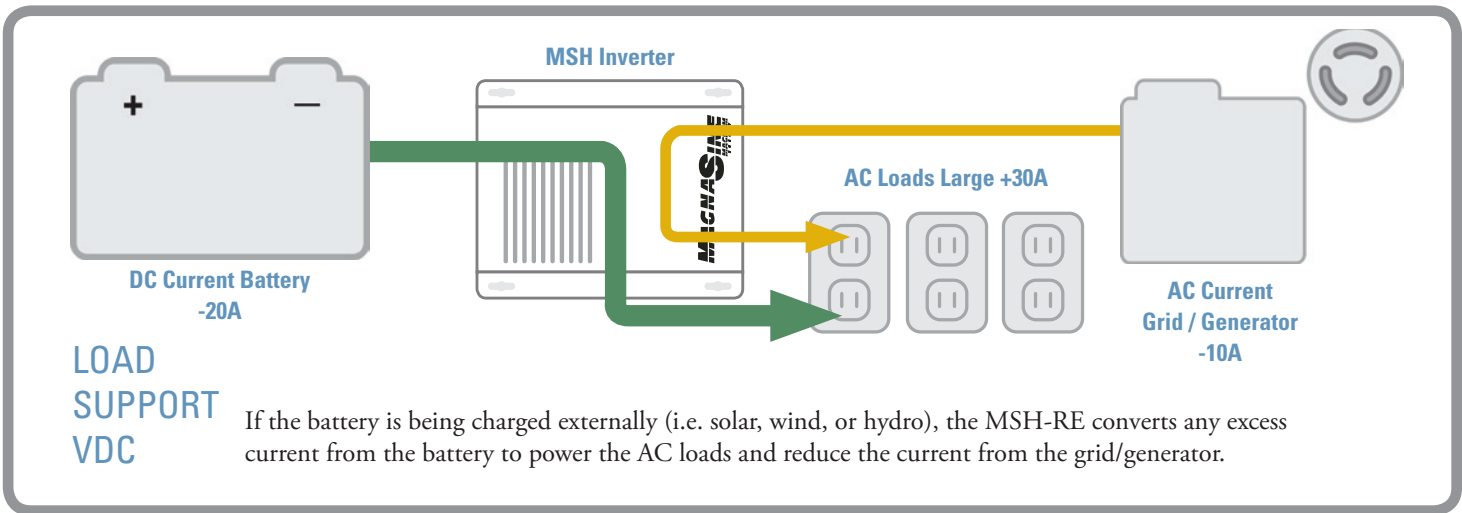
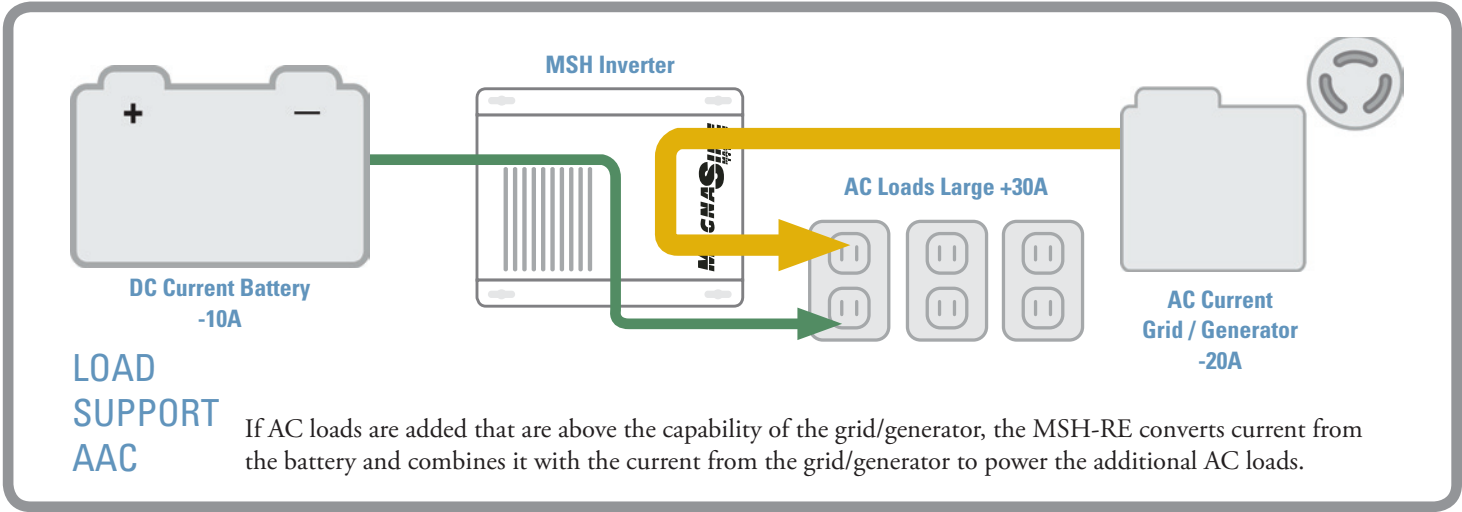

RD SERIES INVERTER / CHARGER

Model Number

RD2212 • RD1824 • RD2824 • RD3924



Modified Sine Wave



Battery Voltage Options



Continuous Output Options
in Watts

Available For

- Renewable Energy Systems
- Off-grid Power
- Backup Power

Available Accessories

	PAGE
AGS.....	36
Battery Monitor Kit	38
Conduit Box.....	40
DC Load Disconnect.....	41
Fuse Blocks.....	41
MagWeb.....	42
MMP Panels	12
Remote - ME-ARC.....	45
Remote - ME-RC.....	46
Remote Switch Adapter.....	47

The RD Series Inverter / Charger is a new generation modified sine wave inverter designed specifically for renewable energy use. The RD Series is powerful, easy-to-use, and best of all, cost effective.

Power Factor Corrected (PFC) Charger: Our PFC charger is built into all of our inverter chargers. It uses less energy from a generator than a standard charger – using 25-30% less AC current than standard chargers.

Safe and reliable: The RD Series is ETL Listed to the stringent requirements of UL 1741 (USA only), ensuring that the inverter is safe and reliable.

Easy-to-install: Install the RD Series in four easy steps: simply connect the inverter’s output to your distribution circuits or electrical panel, connect your power cable (AC) to the inverter’s easy-to-reach terminal block, connect the batteries, and switch on the power.

FEATURES

Choices:

The RD Series comes in four power models and 12 and 24 volt models, allowing you to choose the model that is right for you.

Versatile mounting:

Mount the RD Series on a shelf or wall.

Lightweight:

The lightweight aluminum base and cover also provides noise reduction and corrosion resistance.

Multiple ports:

The RD Series provides multiple ports, including an RS485 communication port for network expansion, and a remote port.

Accessible design:

The extra large AC access cover with terminal screw block and 360° DC connection terminals with covers make this inverter more accessible when it needs to be.

Convenient switches:

The RD Series comes with an on/off inverter-mounted switch with an easy-to-read LED indicator.

Expanded transfer relay:

60 Amp transfer service is available on all models.

Buy with ease:

The RD Series is backed by a two-year (24-month) limited warranty.

RD SERIES SPECIFICATIONS

	RD2212	RD1824	RD2824	RD3924
INVERTER SPECIFICATIONS				
Input battery voltage range	9 - 16 VDC	18 - 32 VDC	18 - 32 VDC	18 - 32 VDC
Nominal AC output voltage	120 VAC ± 5%	120 VAC ± 5%	120 VAC ± 5%	120 VAC ± 5%
Output frequency and accuracy	60 Hz ± 0.1 Hz	60 Hz ± 0.1 Hz	60 Hz ± 0.1 Hz	60 Hz ± 0.1 Hz
1 msec surge current (amps AC)	60	70	100	150
100 msec surge current (amps AC)	37	40	60	90
5 sec surge power (real watts)	3700	4000	6000	8000
30 sec surge power (real watts)	3450	3300	4800	6400
5 min surge power (real watts)	3100	2850	3950	5800
30 min surge power (real watts)	2400	2400	3500	4750
Continuous power output at 25° C	2200 VA	1800 VA	2800 VA	3900 VA
Maximum continuous input current	293 ADC	120 ADC	186 ADC	260 ADC
Inverter efficiency (peak)	95%	94%	93%	93%
Transfer time	16 msec	16 msec	16 msec	16 msec
Search mode (typical)	5 watts	5 watts	5 watts	5 watts
No load (120 VAC output, typical)	20 watts	12 watts	19 watts	25 watts
Waveform	Modified Sine Wave	Modified Sine Wave	Modified Sine Wave	Modified Sine Wave
CHARGER SPECIFICATIONS				
Continuous output at 25° C	110 ADC	50 ADC	80 ADC	105 ADC
Charger efficiency	85%	85%	85%	92%
Power factor	> 0.95	> 0.95	> 0.95	> 0.95
Input current at rated output (AC amps)	15	15	21	29
GENERAL FEATURES AND CAPABILITIES				
Transfer relay capability	2 legs at 30 A for 120 V/30 A or 240 V/60 A service			
Five stage charging capability	Bulk, Absorb, Float, Equalize (requires remote), and Battery Saver™			
Battery temperature compensation	Yes, 15 ft Battery Temp Sensor standard			
Internal cooling	0 to 120 cfm variable speed drive using dual 92mm brushless DC fans			
Overcurrent protection	Yes, with two overlapping circuits			
Overtemperature protection	Yes on transformer, MOSFETS, and battery			
Corrosion protection	Yes, PCB's conformal coated, powder coated chassis/top, and stainless steel fasteners			
Listings	ETL listed to UL1741 (USA only)			
Warranty	Two years			
ENVIRONMENTAL SPECIFICATIONS				
Temperature (Operating/Non-operating)	-20° C to +60° C (-4° F to 140° F) to -40° C to +70° C (-40° F to 158° F)			
Operating humidity	0 to 95% RH non-condensing			
PHYSICAL SPECIFICATIONS				
Dimensions (h x w x d)	13.75" x 12.65" x 8.0" (34.9 cm x 32.1 cm x 20.3 cm)			
Mounting	Shelf or wall (vents up)			
Weight	37 lb (16.9 kg)	35 lb (15.9 kg)	42 lb (19 kg)	53 lb (24 kg)
Shipping weight	46 lb (20.9 kg)	44 lb (20.0 kg)	51 lb (23.2 kg)	62 lb (28.1 kg)
Max operating altitude	15,000' (4570 m)			

Testing for specifications at 25° C. Specifications subject to change without notice.

ACCESSORIES

AUTOMATIC GENERATOR START MODULE (AGS)

Model Numbers
ME-AGS-S • ME-AGS-N



Works With

	PAGE
MM-AE Series.....	24
MMS Series.....	26
MS Series.....	28
MS-PAE Series.....	6
MSH-RE Series.....	32
RD Series.....	34

The ME-AGS-S does not require an inverter/charger.

Available Accessories

- ME-PT1
- ME-PT2

Please call and ask about our PT-1 and PT-2 pigtails for starting on demand applications.



ME-AGS-N FEATURES*

- All settings are adjustable from the ME-RC and ME-ARC remotes.
- Auto start is locked out when utility power is present.
- Portable generator mode.

Imagine being able to enjoy a day away all-the-while knowing your living space will stay cool and comfortable and your batteries will stay charged and ready for all of the activities that make up daily life. There's nothing better than returning to a nice, cool, comfortable home with charged batteries after a day away. The Magnum Energy brand Auto Gen Start (AGS) from Sensata Technologies can make this happen.

The Magnum Energy brand AGS is compatible with most major generators, including Onan, Powertech, Generac, Westerbeke, Kohler, EPS, Northern Lights, and most portable generators with electric start. Please check with your Sensata Technologies dealer for specific model compatibility.

Automatically start your generator:

The AGS is designed to automatically start your generator based on low battery condition or the inside room temperature.

Adjust the AGS to meet your needs:

With the ME-AGS-N you can set multiple parameters for starting and stopping the generator. Using the ME-RC, the ME-AGS-N has basic adjustments starting on battery voltage or temperature. When using the ME-ARC, the ME-AGS-N has advanced start and stop features, including battery voltage, time of day, AC amps, exercise time, and SOC.

Manual start and stop:

Auto Gen Start settings do not interfere with the manual start/stop operation of the generator. Just use any existing start/stop switch for your generator.

Two models are available:

The stand alone version of the AGS (ME-AGS-S) works well for installation and operation without an inverter. The network version of the AGS (ME-AGS-N) allows operation of the AGS via the ME-RC50 or ME-ARC remote panel.

- **ME-AGS-N kit includes:** AGS module (3 relay), 10' network cable, and a 60' remote temperature sensor cable.
- **ME-AGS-S kit includes:** AGS module (3 relay), Remote on/off/test switch, switch bezel, a 25' 6-wire cable, and has basic adjustments starting on battery voltage or temperature.

AGS WIRING DIAGRAM FOR STAND ALONE SYSTEMS (ME-AGS-S)

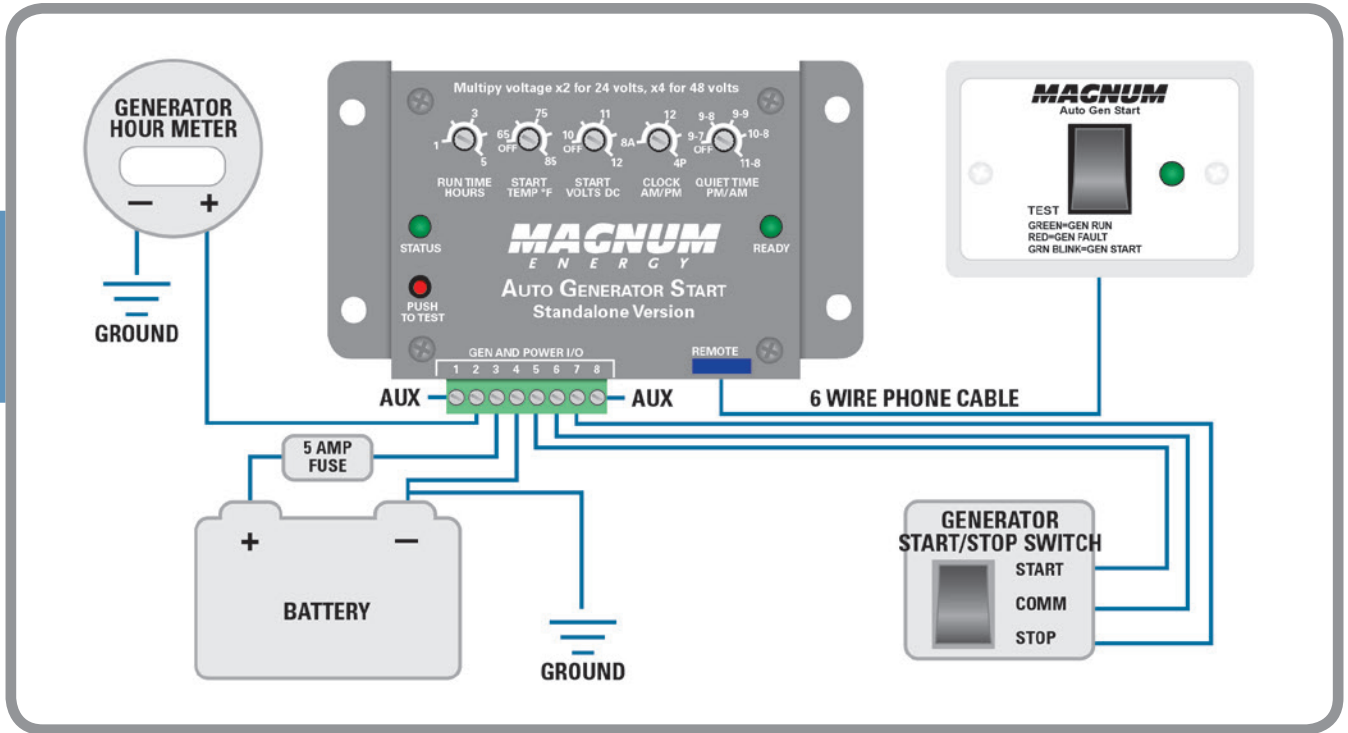

AGS WIRING DIAGRAM FOR NETWORKED SYSTEMS (ME-AGS-N)

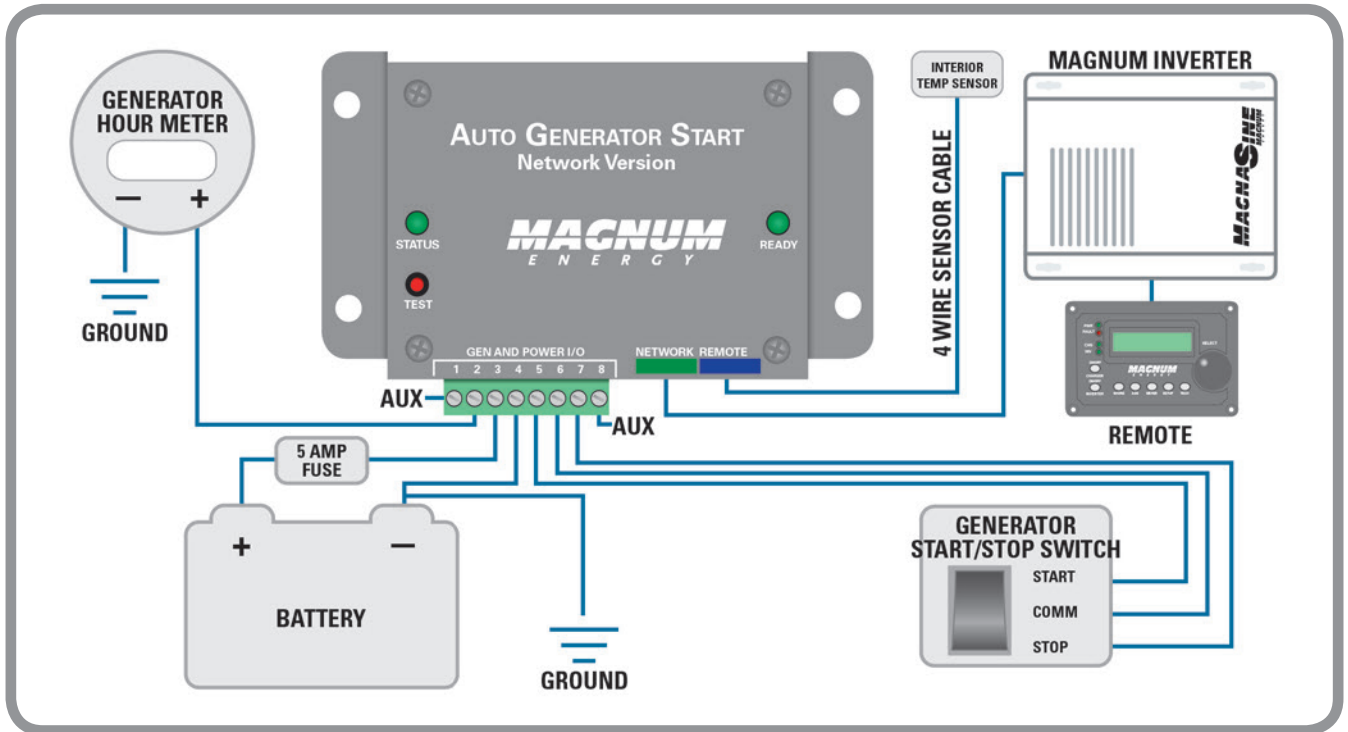

* AGS-N features require Remote rev 1.6 and AGS rev 5.0 or higher.

BATTERY MONITOR KIT (ME-BMK)



Model Numbers
ME-BMK • ME-BMK-NS (no shunt)

Works With

	PAGE
MM-AE Series.....	26
MMS Series.....	28
MS Series.....	30
MS-PAE Series.....	8
MS-RE Series.....	32
RD Series.....	36

The ME-BMK requires an inverter and remote or router to see readings.

Monitoring your battery bank is easy with the Battery Monitor Kit (ME-BMK)* from Sensata Technologies. Acting as a “fuel gauge” for your batteries, the ME-BMK monitors their state of charge (SOC) and then provides this information in an easy-to-understand display via the ME-ARC or ME-RC remotes. With accurate SOC readings, you can avoid unnecessary battery recharging, saving on fuel and long-term maintenance costs.

If you already have a Magnum Energy brand Inverter/Charger and Magnum brand Remote*, the ME-BMK is an easy retrofit. Simply install the kit according to the installation manual and begin monitoring your battery bank via the “Meter” button on your ME-RC.

Available Readings from the ME-BMK / ME-BMK-NS

- State of Charge (SOC) 0 - 100%
- DC volts
- DC amps
- Amp hours in/out
- Resettable amp hours out
- Total amp hours out
- Minimum volts DC
- Maximum volts DC
- Temperature compensated
- Auto detects input voltage

Kit Includes

- Sense module
- DC shunt 50mv/500 amp shunt (not included in the ME-BMK-NS kit)
- Twisted pair wire 5’ length, 18 AWG wire
- Communication cable 10’ length, 4-conductor, telephone standard

Features Available with Magnum Energy products

- PT-100 Charge Controller: wire loss compensation
- ME-AGS Auto Gen Start: start and stop on state-of-charge

* Requires remote revision 2.0 or higher.

ME-BMK SPECIFICATIONS

DC volts	7 to 70 ($\pm 0.5\%$) auto voltage detection
DC amps	± 0.1 to 999 ($\pm 1.0\%$)
Battery SOC %	0 to 100% (1% increments)
Power draw	< .6 watts
Amp hours in/out	$\pm 32,768$ amp hours (1 AH increments)
rAH out (resettable amp hours removed)	0 to 65,535 amp hours, resettable (0.1 AH increments)
tAH out (total amp hours removed)	0 to 65,535,000 amp hours (0.1 k or 100 AH increments)
Minimum/maximim DC	7 to 70 VDC, resettable
Shipping weight	2 lb (.9 kg)
Kit includes	Manual, sense module, DC shunt, twisted pair wire, and communication cable
Sense wire	Twisted pair –blue & orange, 5' length, 18 AWG wire
Communication cable	4-conductor, 10' twisted pair, telephone standard
Remote requirements	Use with an ME-RC with firmware revision of 2.0 or higher or an ME-ARC (all revisions)
DC SHUNT (NOT INCLUDED WITH THE ME-BMK-NS KIT)	
Resistance	0.1 milliohm (500A at 50mV)
Continuous current	410 amperes maximum
Overload current	Overloads to 500 amps for less than 5 minutes if normally operated at less than 300 amps

Testing for specifications at 25° C. Specifications subject to change without notice.

ME-BMK BASIC CONFIGURATION DIAGRAM

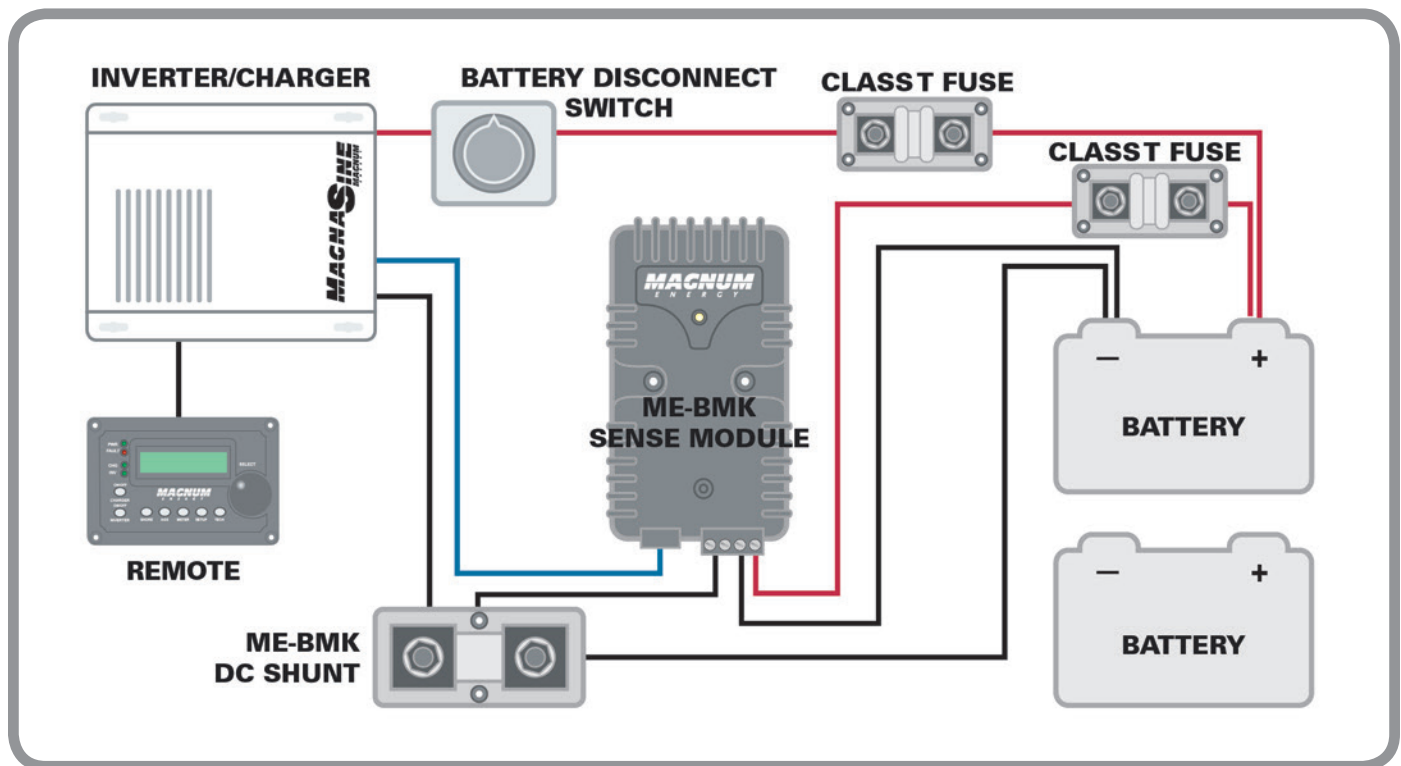

CONDUIT BOX

Model Numbers

- ME-CB

Works With

	PAGE
MS Series.....	28
MS-PAE Series.....	6
MSH-RE Series.....	32
RD Series.....	34

The ME-CB conduit box is designed to work with Magnum ME, MS, MS-PAE, and RD Series Inverter / chargers. It provides an enclosure for AC and/or DC wiring and has knockouts for ½”, ¾”, 1”, and 2” trade-size conduit. The ME-CB adds just over 5” (13 cm) to the length of the inverter.



MAGNUM PANEL EXTENSION CONDUIT BOX

Model Numbers

- MPX-CB

Works With

	PAGE
MS Series.....	28
MS-PAE Series.....	6
MSH-RE Series.....	32
RD Series.....	34

The Magnum Panel Extension Conduit Box – MPX-CB – is the same conduit box that comes in our MPX kits, but does not include AC/DC breakers or wiring.



DC BREAKERS FOR THE PT100 CHARGE CONTROLLER

Works With

	PAGE
PT-100 Charge Controller.....	10

DIN rail mounted breakers to make installing the PT-100 Charge Controller even easier.

MODEL NUMBER	DESCRIPTION
BR-DC100-DIN	100A/125VDC, breaker for battery side of PT-100
BR-PV10-DIN	10A/250VDC, breaker for PV side of PT-100
BR-PV15-DIN	15A/250VDC, breaker for PV side of PT-100
BR-PV20-DIN	20A/250VDC, breaker for PV side of PT-100
BR-PV30-DIN	30A/250VDC, breaker for PV side of PT-100
BR-PV40-DIN	40A/250VDC, breaker for PV side of PT-100
BR-PV50-DIN	50A/250VDC, breaker for PV side of PT-100

DC LOAD DISCONNECT

Model Number

- ME-DCLD

The DC Load Disconnect is a pigtail adapter designed to automatically turn off the inverter via a 12 volt DC disconnect switch.

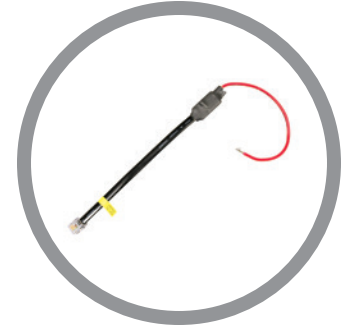

Works With

	PAGE
MS Series.....	28
MSH-RE Series.....	32
RD Series.....	34

Model Number

- MM-DCLD

Works With

	PAGE
MS-AE Series	24

FUSE BLOCKS

Model Numbers

- ME-125F
- ME-200F
- ME-300F
- ME-400F

Protection against costly damage:
The ME-125F, ME-200F, ME-300F, and ME-400F protect the battery bank, inverter, and cables from damage caused by short circuits and overloads.



Works With

	PAGE
ME-125F and ME-200 only	
MM-AE Series.....	24
ME-300F and ME-400F only	
MS Series.....	28
MS-PAE Series.....	6
MSH-RE Series.....	32
RD Series.....	34

Complete kit in one package: Magnum Energy brand fuses include a Slow-Blow high current fuse, a mounting block, and protective cover.



FUSE SELECTION

CONDUCTOR GAUGE	CURRENT CAPACITY	RECOMMENDED FUSE RATING
4 AWG	125	125
1/0 AWG	200	200
2/0 AWG	290	300
3/0 AWG	310	300
4/0 AWG	360	400

THE MAGWEB: WEB MONITORING KIT



Model Numbers
ME-MW-W (wireless) • ME-MW-E (ethernet)

Works With

	PAGE
MM-AE Series	24
MS Series	28
MS-PAE Series	6
MSH-RE Series	32
RD Series	34

The MagWeb is a powerful and cost effective tool for remotely monitoring Sensata Technologies inverters and accessories. Installed on the Magnum network, the MagWeb provides live Internet monitoring of the inverter, battery monitor, and automatic generator start module. Using your always on Internet connection, the MagWeb makes live and historical conditions available to you through a web browser at data.magnumenergy.com.

DATA SAMPLES

The MagWeb constantly streams data to your personal web pages, providing details on Current Conditions, Current Settings, and Daily Summaries for historical records. The samples below provide snapshots of the standard web pages.

WEB-BASED MONITORING

- Inverter/Charger Status
- Program Settings
- Faults
- DC volts, DC amps
- Invert, Charge LEDs
- Tech menus
- Battery Monitor status
- Auto Gen Start (AGS) status

Current Settings

Settings Date:	2010-10-05 18:48:23
Inverter Settings	
Modul:	MS4024
Revision:	3.7
Stack Mode:	Standalone Unit
Remote Settings	
Revision:	2.1
AC Search Watts:	No Searching, Always On
AC Shore Amps:	60
Charger Amps:	20% of full value
Auto Generator Start:	OFF
Battery Size:	1600 amp / hours
Low Battery Cut-Out:	21.0 VDC
Absorb Voltage / Time:	28.8 VDC (for 0.0 hours)
Float Voltage:	27.0 VDC
Equalize Voltage:	28.9 VDC
Battery Monitor	
Revision:	1.0

Daily System Summary

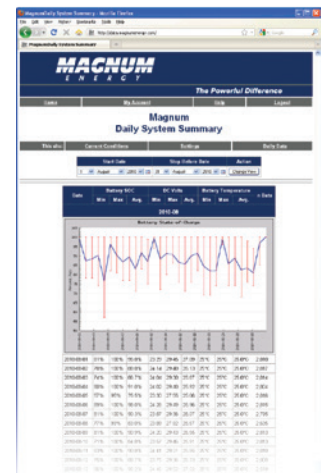

MAGWEB PRO AVAILABLE SOON

The MagWeb Pro will save and display data locally. Don't have an always on internet connection? Connect via a thumb drive, Ethernet cable, or WiFi. The MagWeb Pro will upload your data to the Magnum Server when internet access does become available.

Current Conditions

Date:	2010-10-05 18:50:25
Battery Monitor (DC)	
State of Charge:	100%
Volts / Amps:	26.88 VDC @ 17.2 amps (462 watts)
Amp Hours In / Out:	+89 amp hours
Volts Min / Volts Max:	23.33 VDC Min / 30.42 VDC Max
Inverter	
Status:	Absorb Mode Absorbing with AC
LEDs:	Inverting Charging
Temperatures:	Battery: 25°C / 77°F Transformer: 56°C / 136°F FETs: 41°C / 105°F
AC Out:	Active: (0 amps)
AC In:	Active: (0 amps)



MAGWEB SPECIFICATIONS

ME-MW-W / ME-MW-E

SAMPLE RATE

Fixed 30 second sample interval
2,800 measurements per day

COMMUNICATION – 802.15.4 XBEE WIRELESS

For use with our data.magnumenergy.com service

US version	2.4 GHz, 63 mW (+18 dBm) 300' indoor range, up to one mile line of sight outdoor range
International version	2.4 GHz, 10 mW (+10 dBm) 200' indoor range, up to 2,500' line of sight outdoor range; special order only
Low power version	2.4 GHz, 1 mW (+0 dBm) 100' indoor range, up to 300' line of sight outdoor range; special order only

Direct Sequence Spread Spectrum (DSSS)

RP-SMA connector and included rubber duck antenna

Requires 802.15.4 XBee to Ethernet wireless gateway

Wireless agency approvals	United States (FCC Part 15.247)
	Industry Canada (IC)
	Europe
	Japan
	Australia

POWER DRAW

MagWeb	< 0.1 watts average from Magnum bus
Wireless Gateway	< 4 watts average from 120 VAC

MATERIALS

MagWeb case	ABS plastic, flame retardant, UL94V-0
Wireless Gateway case	Anodized aluminum

All parts are RoHS compliant, no lead used in manufacture

PHYSICAL SPECIFICATIONS

Shipping weight	3 lb (1.36 kg)
-----------------	----------------

KIT INCLUDES

MagWeb 802.15.4	Manual Communications cable (2-conductor, 10' twisted pair, telephone standard) Mounting screws Antenna
Wireless 802.15.4 Gateway	Antenna Ethernet cable, 10' AC adapter (Energy Star, North American plug)

REMOTE REQUIREMENTS

ME-RC or ME-ARC required when monitoring device(s) other than inverter

Testing for specifications at 25° C. Specifications subject to change without notice.

THE MAGWEB GT



Model Numbers
ME-MGT-MW
AVAILABLE SOON

Works With

MicroGT Inverter.....	PAGE 4
MS-PAE Series.....	6

The Magnum Energy MagWebGT is a state-of-the-art communication device to remotely monitor your MicroGT inverters and accompanying battery-based MS-PAE Inverter/Charger, all from one dashboard. Communicating in real time, the MagWebGT will transfer data from each microinverter and MS-PAE to the Sensata webserver, allowing you to access invaluable data on the performance of your system.

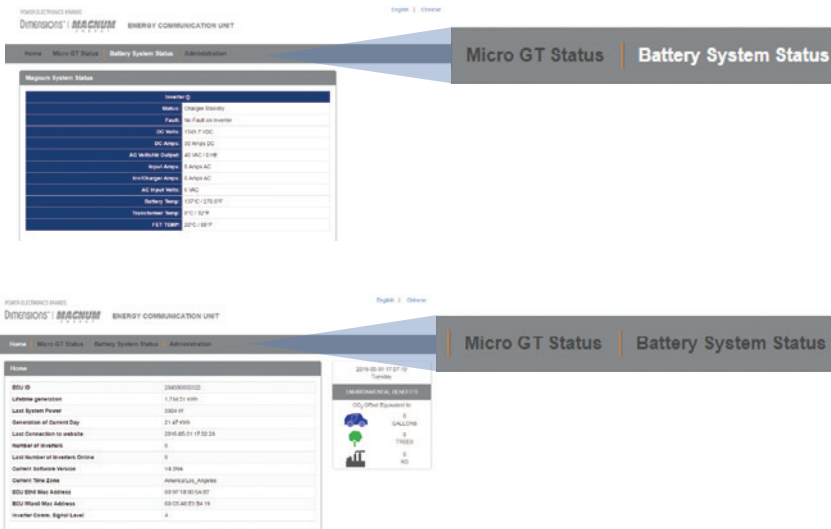

FEATURES

- Collects statistics from both MicroGTs and MS-PAEs installed on the system
- Easy-to-read analytics via any web browser
- Easy network integration PLC or ZigBee communication
- Access live and historical data

COMMUNICATION INTERFACE

Communication	Powerline (PLC) or Zigbee
Ethernet	10/100M
USB Interface	Standard

POWER REQUIREMENTS

AC outlet	110-240 VAC, 50-60 Hz
Power consumption	2.5W

GENERAL FEATURES

Warranty	Three years
Listings	ANSI/UL 60950-1, CAN/CSA C22.2 No.60950-1,UL50E, FCC part 15,ICES-003

ENVIRONMENTAL SPECIFICATIONS

Ambient temperature	Natural Convection
Enclosure environmental rating	Indoor-NEMA 1 (IP30)

PHYSICAL SPECIFICATIONS

Dimension (WxHxD)	7.1" x 4.4" x 1.6" (18.0 cm x 11.2 cm x 4.1 cm)
Weight	0.83lbs (.38 kg)

Testing for specifications at 25° C. Specifications subject to change without notice.

OUTDOOR ENCLOSURE – NEMA 3R-RATED – MP-ODE

Model Numbers

- MP-ODE

The NEMA 3R-rated MP-ODE weather-resistant, protective outdoor enclosure is designed to install your Magnum Energy system, including inverter/charger, PT-100 controller, MMP, and remote control. The MP-ODE has gasket-lined openings protecting against falling rain, sleet, snow and external ice formation. It also has screened ventilation slots to prevent debris or pests from entering and to ensure adequate airflow, multiple knockouts to facilitate conduit installation for wire runs, and pre-drilled holes for securing it to a vertical surface.

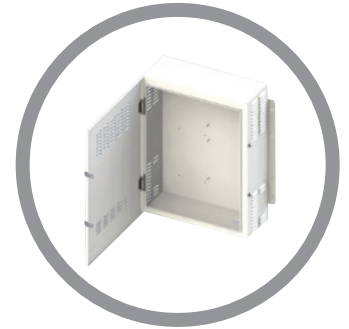

REMOTE - ME-ARC

Model Numbers

- ME-ARC50
Includes ME-RC-BZ bezel

Works With

	PAGE
MM-AE Series	24
MS Series	28
MS-PAE Series	6
MSH-RE Series	32
RD Series	34

This advanced feature remote offers the same simple push button operation of the ME-RC with advanced features and setup menus. The ME-ARC features a **Favs** button for storing up to five of your favorite setup menus, a **Control** button for fast easy control of the inverter, charger, and generator, meter button with AC and DC meters, advanced setup menus, and advanced tech menus.

Easy-to-read: The large LCD screen and at-a-glance LEDs display the inverter/charger status in a straightforward way. Soft keys give simple access to menus and a rotary encoder knob makes it easy to quickly scroll through menus and select settings.

Non-volatile memory: Critical settings are saved even if the power is disconnected.



No cross platform confusion:

The ME-ARC remote is the same remote used on all Magnum Energy brand Inverter/Charger models in the ME, MS, MS-PAE, RD, MM, and MMS lines.

A standard 50' 4-wire, twisted pair cable allows for plenty of room to display the Remote with ease.

REMOTE - ME-RC

Model Numbers

- ME-RC50

Works With

	PAGE
MM-AE Series	24
MS Series	28
MS-PAE Series	6
MSH-RE Series	32
RD Series	34

The ME-RC is designed to be simple to use while offering multiple functions in one place.

Comes with a standard 50' 4-wire, twisted pair cable.



REMOTES -MM-RC

Model Numbers

- MM-RC25

Works With

	PAGE
MMS Series	26

The low-cost, easy-to-read MM-R and MM-RC Remotes are designed to work with the MM and MMS Series Inverters and Inverter/Chargers.



FEATURES

LEDs	Three LEDs: Invert, AC In, and Fault Modes Six LEDs: Invert, AC In, Fault Modes, Bulk, Absorb, and Float On/Off: Turns inverter or charger on or off and defeats "search" mode
Mounting	Includes bezel for surface mount or flush mount
Included with the Remote	25' phone cable

ROUTER - ME-RTR

Model Numbers

- ME-RTR

Works With

	PAGE
MS-PAE	6

The Magnum Energy brand Router from Sensata Technologies is a combination of the ME-ARC advanced feature remote and a communication hub for MS-PAE parallel units all in one easy-to-install and operate unit. The ME-RTR features full inverter/charger setup and control, four-line LCD display, four parallel stacking ports for the MS-PAE Series inverter/charger, communication ports for ME-AGS-N or ME-BMK accessories, and a two wire voltage controlled auxiliary relay.



REMOTE BEZEL - ME-RC-BZ

Model Numbers

- ME-RC-BZ

Mounting bezel for the ME-RC remote, allowing the ME-RC to be surface mounted.

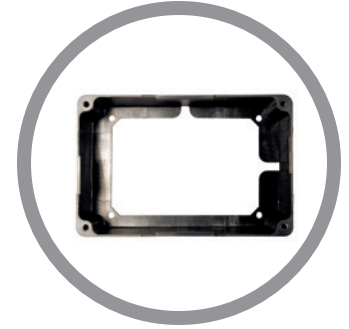

Works With

	PAGE
ME-RC	46

REMOTE SWITCH ADAPTER

Model Numbers

- ME-RSA (use SPST switch)
- ME-RSA-M (use momentary switch)

The Remote Switch Adapter is a pigtail adapter designed to provide a simple on/off remote switch.



Works With

	PAGE
MS Series	28
MSH-RE Series	32
RD Series	36

SERIES STACKING CABLE KIT

Model Numbers

- ME-SSI

The Series Stacking Cable Kit allows two inverters to be stacked together to achieve 120/240 VAC output. Series stacking is commonly used for well pumps, tools, motors, and other 240 VAC appliances. The kit includes communication cable, two 2/0 battery cables, and battery lug covers.



Works With

	PAGE
MS4024	28
MS4048	28

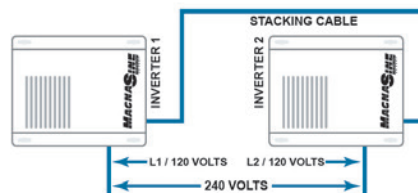

ACCESSORY AND INVERTER CROSS-REFERENCE

Chart provided for reference only.

Please see product and accessory descriptions for full compatibility.

SERIES NAME	MicroGT 500 Inverter	MS-PAE Series Inverter/Charger	MM-AE Series Inverter/Charger	MMS Series Inverter/Charger	MS Series Inverter/Charger	MSH-RE Series Inverter/Charger	RD Series Inverter/Charger
OUTPUT POWER RANGE	500W	4000-4400W	600-1500W	1000W	2000-4000W	4000W	1800-3900W
ACCESSORY NAME							
AC Load Diversion Controller (ACLD-40)		●					
Automatic Generator Start (ME-AGS)		●			●	●	●
Battery Monitor Kit (ME-BMK)		●	●		●	●	●
Conduit Box (ME-CB & MPX-CB)		●			●	●	●
DC Load Disconnect (ME-DCLD)				●	●	●	●
Fuse Blocks		●	●	●	●	●	●
MagWeb		●	●	●	●	●	●
MagWeb GT	●	●					
MMP Panels		●			●	●	●
MP Panels		●			●		
Charge Controller (PT-100)		●			●	●	
Remote - Advanced (ME-ARC)		●	●	●	●	●	●
Remote (ME-RC)		●	●	●	●	●	●
Remote (MM-RC)				●			
Remote Switch Adapter (ME-RSA)					●	●	●
Router (ME-RTR)		●					
Series Stacking Interface (ME-SSI)					●		

NOTES



OFFICES
2211 West Casino Road
Everett, Washington 98204 USA
425-353-8833

4467 White Bear Pkwy
St. Paul, MN 55110 USA
800-553-6418